



**nobis**  
YOUR STOVE, OUR PASSION



**2024**

CATALOGO GENERALE / CATALOG / CATALOGUE / KATALOG

**PRODOTTI 2024**  
 PRODUCTS | PRODUITS | PRODUKTE



**BI-FUEL / HYBRID**



LIBERA ..... 42  
 UNICA ..... 48

**STUFE A PELLETT**

PELLET STOVES / POÊLES A GRANULÉS / PELLETOFEN



A8 | A10 ROUND ..... 50  
 A8 | A10 ROUND TOP - COAX ..... 50  
 A8 | A10 ROUND GLASS ..... 54  
 A8 | A10 ROUND GLASS TOP - COAX ..... 54  
 A8 | A10 ROUND STEEL ..... 58  
 A8 | A10 ROUND STEEL TOP - COAX ..... 58  
 B10 V ULISSE CLASSIC ..... 60  
 A9 ZENITH ..... 62  
 A10 ZENITH PLUS ..... 64  
 A8 QUADRA ..... 66  
 A8 QUADRA TOP ..... 66  
 A10 QUADRA PLUS ..... 68  
 A10 QUADRA PLUS TOP ..... 68  
 A9 CLASSIC ..... 70  
 A10 CLASSIC PLUS ..... 72  
 A8 | A10 STYLE ..... 74  
 A10 LIGHT ..... 76  
 A10 LIGHT STYLE ..... 80  
 A10 LIGHT 2020 ..... 82  
 7 | 10 LISA ..... 84  
 12 ELENA ..... 86  
 12 ELENA STYLE ..... 88  
 A11 | A13 ROUND ..... 90  
 A11 | A13 ROUND TOP - COAX ..... 90  
 A11 | A13 ROUND GLASS ..... 92  
 A11 | A13 ROUND GLASS TOP - COAX ..... 92  
 A11 | A13 ZENITH ..... 94  
 A11 | A13 ZENITH PLUS ..... 96

**CAMINI A PELLETT**

PELLET INSERTS / INSERTS A GRANULÉS / PELLETEINSATZ



B10 V ULISSE ..... 100  
 B10 C ULISSE ..... 102  
 B13 ULISSE ..... 104  
 HB14 ULISSE ..... 108  
 HB17 ULISSE ..... 108

**TERMOSTUFE A PELLETT**

PELLET THERMOSTOVES / THERMOPOÊLES / THERMOÖFEN



H10 | H12 V SHAPE ..... 112  
 H10 | H12 V SHAPE GLASS ..... 114  
 H14 | H17 V SHAPE STEEL ..... 116  
 H14 | H17 V SHAPE ROUND ..... 118  
 H17 V LIGHT ..... 120  
 H17 V SHAPE MAIOLICA ..... 124  
 H20 V SHAPE STEEL ..... 126  
 H20 V SHAPE MAIOLICA ..... 126  
 H25 V SHAPE STEEL ..... 128  
 H25 V SHAPE MAIOLICA ..... 128

**CALDAIE A PELLETT**

BOILERS / CHAUDIÈRES / KESSEL



POLYGON 25 ..... 132  
 POLYGON 28 ..... 134  
 POLYGON 32 ..... 136

**GAMMA LEGNA**

WOOD RANGE / GAMME BOIS / DAS HOLZSORTIMENT



EFREM CLASSIC 700<sup>49</sup> / 800<sup>55</sup> ..... 144  
 FLAT 100 ..... 146  
 FLAT 300 | FLAT 330 ..... 148  
 FLAT 500 | FLAT 550 ..... 150  
 FLAT 700 | FLAT 770 ..... 152  
 ZENITH 400 | ZENITH 440 ..... 154  
 ZENITH 600 | ZENITH 660 ..... 156  
 ZENITH 800 | ZENITH 880 ..... 158  
 CLASSIC 200 | CLASSIC 220 ..... 160  
 EFREM 700<sup>49</sup> / 800<sup>49</sup> / 900<sup>49</sup> ..... 162  
 EFREM 700<sup>55</sup> / 800<sup>55</sup> / 900<sup>55</sup> ..... 164  
 EFREM FLY 700<sup>49</sup> / 800<sup>55</sup> ..... 166

**CUCINE**

COOKERS / CUISINIÈRES / HERDE



LINA 80 / LINA 90 ..... 172  
 OLGA 80 / OLGA 90 ..... 174



**NOI SIAMO NOBIS**

WE ARE NOBIS • NOUS SOMMES NOBIS • WIR SIND NOBIS ..... 2

**SIMPLY INNOVATE**

ELEMENTO SOFTWARE ..... 6

**SIMPLY DESIGN**

BEAUTY AND FUNCTIONALITY ..... 8

**SIMPLY NEUTRAL**

NOBIS SUSTAINABILITY ..... 10

**THE ORIGINAL BRAZIER**

SIMPLY NOBIS ..... 12

**SIMPLY CLEAN**

AUTOMATIC CLEANING ..... 16

**SIMPLY PERFECT**

OPTIMIZE COMBUSTION ..... 18

**SIMPLY SILENT**

BRUSHLESS TECHNOLOGY ..... 20

**SIMPLY TIMELESS**

LONG-LASTING MATERIALS ..... 22

**CONNECT**

EVERYWHERE AND EVERYWHEN - WIFI TECHNOLOGY ..... 24

**SHINE**

TRANSPARENT GLASS ..... 26

**SAVE**

PELLET OPTIMIZER ..... 28

**STUFE ARIA**

AIR STOVES / POÊLES À AIR / LUFTÖFEN ..... 30

**HYBRID | BI-FUEL**

FREE TO CHOOSE ..... 32

**LIBERA**

BI-FUEL ..... 38

**UNICA**

HYBRID ..... 44

**STUFE A PELLETT**

PELLET STOVE / POÊLES À GRANULÉS / PELLETÖFEN ..... 50

**CAMINI A PELLETT**

PELLET INSERTS / CHEMINÉES À GRANULÉS / EINLAGEN ..... 98

**TERMOSTUFE**

THERMOSTOVES / THERMOPÊLES / THERMOÖFEN ..... 106

**CALDAIE A PELLETT**

BOILERS / CHAUDIÈRES / KESSEL ..... 130

**STUFE A LEGNA**

WOOD STOVES / POÊLES À BOIS / HOLZÖFEN ..... 138

**CAMINI A LEGNA**

WOOD INSERTS / CHEMINÉES À BOIS / EINLAGEN ..... 162

**CUCINE A LEGNA**

COOKERS / CUISINIÈRES / HERDE ..... 168

**DATI TECNICI**

TECHNICAL DATA | DONNÉS TECHNIQUE ..... 176



## Semplicemente unica

Nobis è l'espressione di una tecnologia evoluta che ha a cuore il benessere delle persone.

È la stufa di nuova generazione con ottime performance, elevati standard di affidabilità e uno straordinario comfort. È silenziosa, è autonoma, è sicura, è rispettosa dell'ambiente, è certificata secondo i più alti standard richiesti dagli enti nazionali e internazionali. Gestisce in modo automatico il ciclo di pulizia, riduce al minimo la manutenzione manuale, ha componenti resistenti nel tempo, e consente un risparmio nei consumi di pellet ed elettricità.

**Una stufa semplicemente unica,  
una stufa semplicemente Nobis.**

## Tout simplement, unique

Nobis est l'expression d'une technologie avancée qui a à cœur le bien-être des personnes.

Un poêle de nouvelle génération avec d'excellentes performances, des normes de fiabilité élevées et un confort extraordinaire. Silencieux, automatique, et respectueux de l'environnement, notre poêle assure une sécurité optimale et est certifié selon les normes les plus élevées exigées par les organismes nationaux et internationaux. La gestion automatique du cycle de nettoyage minimise le besoin d'entretien manuel et, grâce à des composants durables, permet d'économiser à la fois des granulés et de l'électricité.

**Notre poêle est unique en son genre.  
Tout simplement unique, tout simplement Nobis.**

## Simply unique

Nobis is the expression of an advanced technology that has people's well-being at heart.

A next-generation stove with excellent performance, high reliability standards, and extraordinary comfort. Silent, automatic, safe, and environmental friendly, our stove is certified in accordance with the highest standards required by national and international bodies. The automatic management of the cleaning cycle minimizes the need for manual maintenance, and with durable components, it allows to save both pellet and electricity.

**Our stove is one of a kind.  
Simply unique, simply Nobis.**

## Einfach einzigartig

Nobis ist Ausdruck einer fortschrittlichen Technologie, bei der das Wohlbefinden der Menschen im Mittelpunkt steht.

Es handelt sich um einen Ofen der neuen Generation mit hervorragender Leistung, hoher Zuverlässigkeit und außergewöhnlichem Komfort. Es ist leise, autonom, sicher, umweltfreundlich und nach den höchsten nationalen und internationalen Standards zertifiziert. Es verwaltet den Reinigungszyklus automatisch, reduziert die manuelle Wartung auf ein Minimum, verfügt über langlebige Komponenten und ermöglicht Einsparungen beim Pellet- und Stromverbrauch.

**Ein einfach einzigartiger Ofen,  
ein einfacher Nobis-Ofen**



## Noi siamo Nobis

Un'azienda di persone non di numeri. Il significato di Nobis "con noi" esprime immediatamente la nostra filosofia. NOI; una parola che include le persone che lavorano in azienda, i nostri clienti, i nostri centri assistenza e i nostri fornitori. Il successo va raggiunto insieme, con la passione per il nostro lavoro che ogni giorno ci porta ad affrontare nuove sfide e nuovi obiettivi. Gli obiettivi di Nobis sono ambiziosi e un team esperto rende ogni sfida possibile e ogni obiettivo raggiungibile.

Con Noi c'è il cliente che è il centro del nostro interesse, di tutte le nostre attività, decisioni e politiche aziendali. Il cliente è il primo riferimento per il nostro sviluppo futuro: ogni problema, tecnico o logistico, è un'opportunità di crescita aziendale e professionale.

Il cliente è il partner con cui affrontiamo il futuro, per offrire ogni giorno i prodotti con la tecnologia più avanzata nel settore, e per vincere le nuove sfide che il mercato globale oggi ci impone.

## We are Nobis

Nobis is a company made up of people, not numbers. The meaning of the word, which stems from Latin ("with us") is a direct expression of our philosophy. Us: a word whose meaning encompasses not only all those people working at our company, but also our customers, service centers and suppliers. The passion for the work we do is key to our success, and leads us on to face new challenges and new goals, each and every day. Nobis' objectives are ambitious, but thanks to our team of industry experts, every goal is achievable and no challenge is impossible.

With 'us' are our customers, who are at the core of our care, activities, decisions and company policies. Our customers are the first reference point for our development and our growth: every issue, be it technical or logistic, is turned into an opportunity for business and professional growth.

Our customers are the partners we want to face the future with, to deliver cutting-edge products and overcome the new challenges set by today's global market.



## Nous sommes Nobis

Une entreprise de personnes, pas de chiffres. La signification de Nobis (“avec nous”) exprime instantanément notre philosophie. Derrière le mot NOUS, il y a les personnes qui travaillent dans l’entreprise mais également nos clients, nos centres de services et nos fournisseurs. La clé du succès se fait avec la passion pour notre travail qui nous conduit chaque jour à relever de nouveaux défis et à atteindre de nouveaux objectifs. Les objectifs de Nobis sont ambitieux. Pour cela, une équipe expérimentée depuis des années dans le secteur rend chaque défi possible et chaque objectif réalisable. Nobis srl est une entreprise de personnes, d’experts dans le secteur, de

personnes qui avec passion et amour se dédient à leur travail. Avec nous, il y a le client qui est au centre de nos intérêts, de toutes nos activités, des décisions et politiques de l’entreprise. Le client est la première référence de notre développement et de notre croissance. Tout problème, qu’il soit technique ou logistique, est une opportunité de croissance pour les entreprises et les professionnels.

Le client est le partenaire avec lequel Nobis srl entend faire face à l’avenir, aux nouveaux défis que le marché mondial nous impose aujourd’hui.

## Wir sind Nobis

Nobis ist ein Unternehmen, das aus Menschen besteht, nicht aus Zahlen. Die Bedeutung des aus dem Lateinischen stammenden Wortes Nobis, also „mit uns“, ist ein direkter Ausdruck unserer Philosophie.

„Uns“: ein Wort, dessen Bedeutung nicht nur alle Menschen umfasst, die bei Nobis arbeiten, sondern auch unsere Kunden, Servicezentren und Lieferanten.

Die Leidenschaft für die Arbeit, die wir leisten, ist der Schlüssel zu unserem Erfolg und führt uns jeden Tag dazu, uns neuen Herausforderungen und neuen Zielen zu stellen.

Die Ziele von Nobis sind ehrgeizig, aber dank unseres Teams aus Branchenexperten ist jedes

Ziel erreichbar und keine Herausforderung unmöglich.

Mit „uns“ stehen unsere Kunden im Mittelpunkt unserer Betreuung, Aktivitäten, Entscheidungen und Unternehmensrichtlinien. Unsere Kunden sind der erste Bezugspunkt für unsere Entwicklung und unser Wachstum: Jedes Problem, sei es technisch oder logistisch, wird in eine Chance für geschäftliches und berufliches Wachstum verwandelt.

Unsere Kunden sind die Partner, mit denen wir in die Zukunft gehen, innovative Produkte liefern und die neuen Herausforderungen des heutigen globalen Marktes meistern wollen.



1

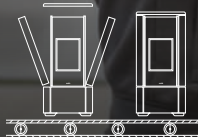

**ASSEMBLAGGIO**  
ASSEMBLY / ASSEMBLAGE /  
MONTAGE

2



**SOFTWARE ELEMENTO**  
ELEMENTO / LOGICIEL ELEMENTO /  
SOFTWARE ELEMENTO

3

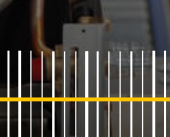

**DATABASE**  
DATABASE / BASE DE DONNÉES /  
DATENBANK

4



**PRIMA ACCENSIONE**  
FIRST IGNITION / PREMIER ALLUMAGE /  
ERSTZÜNDUNG

## 100% tested, ogni singola stufa

La qualità dei nostri prodotti è il risultato di un processo continuo di controllo. Dalla progettazione alla scelta dei materiali, dall'assemblaggio alla prima accensione, le nostre stufe sono testate in ogni dettaglio nel rispetto dei nostri standard costruttivi.

### ASSEMBLAGGIO

I componenti vengono verificati all'arrivo in azienda e durante tutta la linea di montaggio, dal corpo stufa alle saldature, alla componentistica meccanica e ai cablaggi di motori e sonde. Viene inoltre effettuato il test di ermeticità di ogni singola stufa.

### ATTIVAZIONE SOFTWARE

Sulla scheda elettronica e sul palmare vengono caricati i firmware di funzionamento e il software per il controllo della stufa. Attraverso una prova di funzionamento viene effettuato il controllo di tutta la componentistica da un punto di vista elettrico e meccanico.

### DATABASE ENTRY

Ogni singolo componente viene associato alla matricola stufa e viene creata l'anagrafica prodotto. I dati sono caricati a sistema e permettono l'attivazione della garanzia, il monitoraggio delle funzionalità della componentistica e l'assistenza sul prodotto.

### PRIMA ACCENSIONE

Al termine della linea di produzione effettuiamo un test di prima accensione su ogni singola stufa. L'accensione dura circa 20 minuti, nei quali viene verificato il funzionamento dell'autopulizia, dei motori, i parametri di combustione e dei sistemi di sicurezza.



## 100% tested stoves

The quality of our products is the result of continuous control. From design to the choice of materials, from assembly to first ignition, nothing is left to chance: our stoves are tested in every detail, in accordance with our manufacturing standards.

### ASSEMBLY

All components are checked upon arrival at our premises and throughout the assembly stage: from the stove body, welds, and mechanical components up to motor and probe wiring. The stove air-tightness is also tested for hermetic installation.

### SOFTWARE ACTIVATION

The product firmware and the stove management software are installed on both the electronic board and the remote control. A test run is carried out to check the functioning of electrical and mechanical components.

### DATABASE ENTRY

Each component is paired with the stove serial number, and then product master data are created. Such data are uploaded to the system to activate the product warranty, the function monitoring system, and the technical assistance service.

### FIRST IGNITION

At the end of the production line, a first-ignition test is carried out on each stove. This test lasts around 20 minutes, a time during which proper functioning of the stove self-cleaning system, motors, combustion parameters and safety systems are thoroughly checked.

## Chaque poêle 100% testé

La qualité de nos produits est le résultat d'un processus de contrôle continu. De la conception au choix des matériaux et du montage au premier allumage, nos poêles sont testés dans les moindres détails, dans le respect des normes de construction du secteur.

### ASSEMBLAGE

Lorsque les composants arrivent dans l'entreprise et tout au long de la chaîne de montage : du corps du poêle aux soudures, des composants mécaniques au câblage des moteurs et des sondes, ils sont contrôlés. Le test d'étanchéité de chaque poêle individuel est également effectué.

### ACTIVATION DU LOGICIEL

Le micrologiciel de fonctionnement et le logiciel de contrôle du poêle sont chargés sur la carte électronique et le télécommande. Grâce à un test fonctionnel, tous les composants sont vérifiés d'un point de vue électrique et mécanique.

### BASE DE DONNÉES

Chaque composant individuel est associé au numéro de série du poêle, ainsi les données de base du produit sont créées. Les données sont chargées dans le système et permettent l'activation de la garantie, le suivi de la fonctionnalité des composants et l'assistance sur le produit.

### PREMIER ALLUMAGE

A la fin de la chaîne de production, nous effectuons un premier test d'allumage sur chaque poêle. L'allumage dure environ 20 minutes, pendant lesquelles le fonctionnement de l'autonettoyage et des moteurs des paramètres de combustion et des systèmes de sécurité sont vérifiés.

## 100 % geprüfte Öfen

Die Qualität unserer Produkte ist das Ergebnis einer kontinuierlichen Kontrolle. Vom Design bis zur Materialauswahl, von der Montage bis zur ersten Zündung wird nichts dem Zufall überlassen: Unsere Öfen werden gemäß unseren Fertigungsstandards bis ins kleinste Detail getestet.

### MONTAGE

Alle Komponenten werden bei der Ankunft in unserem Betrieb und während der gesamten Montagephase überprüft: vom Ofenkörper über die Schweißnähte und mechanischen Komponenten bis hin zur Motor- und Sondenverkabelung. Außerdem wird die Luftdichtheit des Ofens auf hermetische Installation geprüft.

### SOFTWARE-AKTIVIERUNG

Die Produkt-Firmware und die Ofenverwaltungssoftware sind sowohl auf der Elektronikplatine als auch auf der Fernbedienung installiert. Es wird ein Testlauf durchgeführt, um die Funktionsfähigkeit der elektrischen und mechanischen Komponenten zu überprüfen.

### DATENBANKEINTRAG

Jede Komponente wird mit der Seriennummer des Ofens gepaart und anschließend werden Produktstammdaten erstellt. Diese Daten werden in das System hochgeladen, um die Produktgarantie, das Funktionsüberwachungssystem und den technischen Kundendienst zu aktivieren.

### ERSTE ZÜNDUNG

Am Ende der Produktionslinie wird an jedem Ofen ein Erstzündungstest durchgeführt. Dieser Test dauert etwa 20 Minuten. Dabei wird die ordnungsgemäße Funktion des Selbstreinigungssystems des Ofens, der Motoren, der Verbrennungsparameter und der Sicherheitssysteme gründlich überprüft.





simply  
**INNOVATE**

**nobis**

# elemento

## Semplicemente innovativa

**Elemento** è il software che gestisce la prestazione e la sicurezza di ogni prodotto Nobis.

Il reparto di ricerca e sviluppo ha reinventato il funzionamento della stufa a pellet: ogni processo viene gestito con particolare attenzione.

**Elemento** è un software intelligente che regola la stufa in base al pellet utilizzato, all'ambiente e all'installazione, garantendo standard di sicurezza mai introdotti nel settore.

## Tout simplement, innovant

**Elemento** est le logiciel innovant qui gère performances et sécurité de chaque produit Nobis.

Le département de recherche et développement a réinventé le fonctionnement du poêle à granulés. Chaque processus est géré avec un soin particulier.

**Elemento**, un logiciel intelligent qui régule le poêle indépendamment des granulés utilisés et des différentes installations, garantissant ainsi des niveaux de sécurité jamais vus dans le secteur.

## Simply innovative

**Elemento** is an innovative software installed on every Nobis product to manage performance and safety.

Our R&D department has reinvented the functioning of pellet stoves, and each process is managed with utmost attention to detail.

**Elemento** is a smart software designed to adjust the stove according to the pellets in use, the environment and the type of installations to guarantee unparalleled safety standards.

## Einfach innovativ

**Elemento** ist eine innovative Software, die auf jedem Nobis-Produkt installiert ist, um Leistung und Sicherheit zu verwalten.

Unsere Forschungs- und Entwicklungsabteilung hat die Funktionsweise von Pelletöfen neu erfunden und jeder Prozess wird mit größter Liebe zum Detail verwaltet.

**Elemento** ist eine intelligente Software, die den Ofen an die verwendeten Pellets, die Umgebung und die Art der Installation anpasst, um beispiellose Sicherheitsstandards zu gewährleisten.

## Semplice da usare, semplicemente bella

Per noi bellezza e funzionalità sono due facce della stessa medaglia.

Per questo progettiamo i nostri prodotti tenendo a mente che devono essere facili da usare e pulire, devono adattarsi alle dimensioni e al contesto in cui vengono installati e devono essere belli da vedere.

L'estetica e la scelta dei materiali e colori dei rivestimenti è affidata a designer esperti, che conoscono il mondo dell'arredamento e dell'architettura, e esplorano ogni giorno nuove tendenze.

La nostra gamma comprende prodotti dalla forma classicheggiante con rivestimenti in maiolica, forme moderne con pannelli in vetro colorato o a effetto carbonio, silver o wengé, e si arricchisce di pannelli in gres con effetto pietra naturale: dal marmo di carrara alle venature dorate della colorazione night.

Ogni prodotto ha un vestito perfetto, la sintesi tra design e funzionalità.

## Easy to use, simply beautiful

For us, beauty and functionality are two sides of the same coin.

That is why, when designing our products, we always keep into consideration how important it is to create products easy to use and clean, suitable for the premises where they are to be installed, and appealing to the eye.

Aesthetics, choice of materials and colors of the covering panels are entrusted to experienced designers from the world of furniture and architecture, who explore new trends every day.

Our range of products includes classic products with majolica cladding, as well as modern shapes with coloured glass or carbon, silver or wenge effect panels, and is enriched with stoneware panels with a natural stone effect: from Carrara marble up to the golden veins of our Night models.

Each product is characterized by unique aesthetics, embodying a perfect mix of design and functionality.

## Facile à utiliser, tout simplement magnifique

Pour nous, la beauté et la fonctionnalité sont deux faces d'une même médaille.

Pour cette raison, nos produits sont faciles à utiliser et à nettoyer, s'adaptent à la taille du lieu, s'intègrent au contexte dans lequel ils sont installés et sont également beaux à regarder.

L'esthétique, ainsi que le choix des matériaux et des couleurs des revêtements, sont confiés à des designers experts, qui connaissent le monde du meuble, de l'architecture et qui explorent chaque jour les nouvelles tendances.

Notre gamme comprend des produits de forme classique avec un revêtement en faïence, des formes modernes avec des panneaux de verre coloré ou avec un effet carbone, argent ou wengé ; s'enrichit de panneaux en grès effet pierre naturelle : du marbre de Carrare aux veines dorées de la couleur nuit.

La fonctionnalité de chaque produit épouse le design parfait.



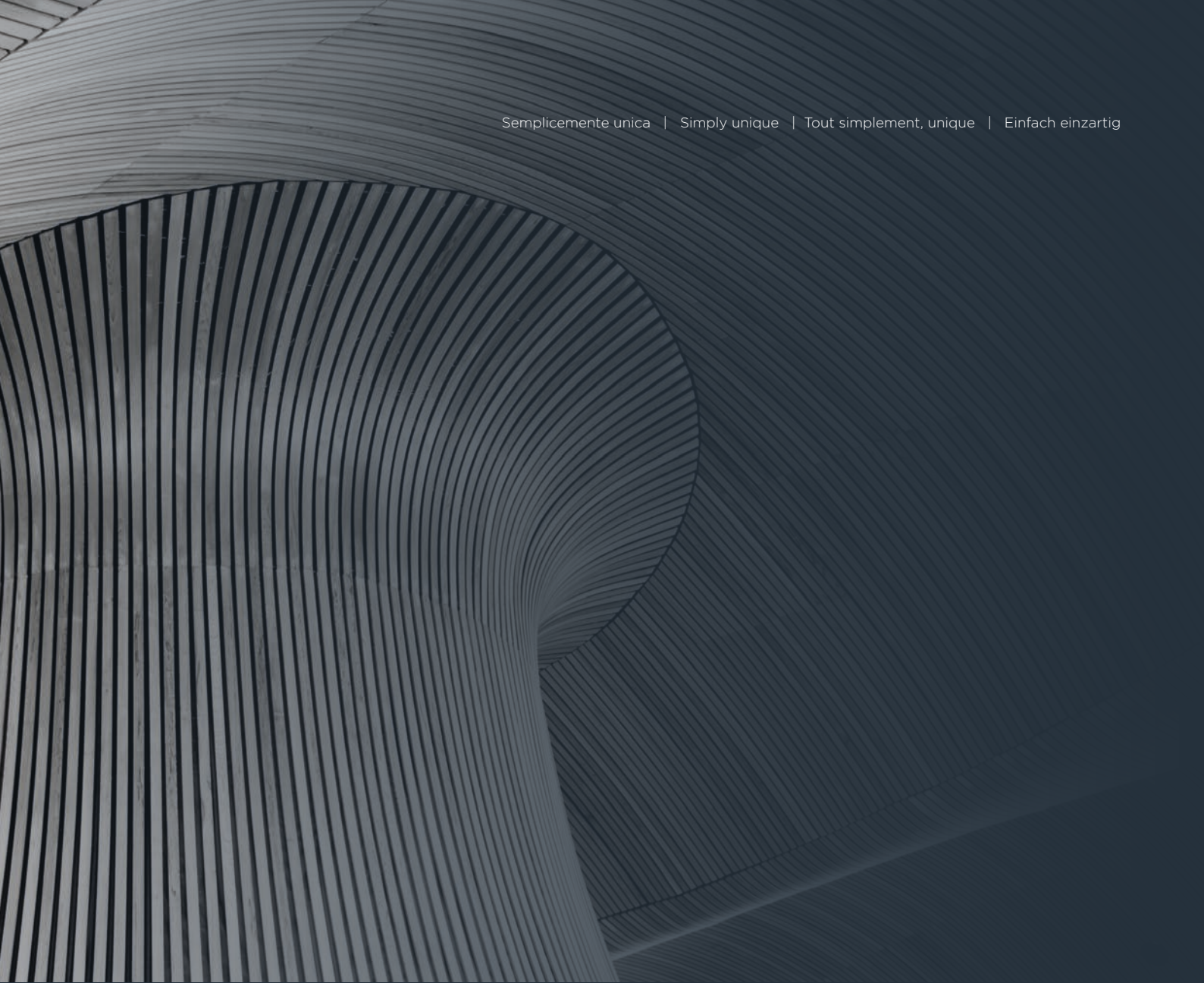

## Einfach zu bedienen, einfach schön

Schönheit und Funktionalität sind für uns zwei Seiten derselben Medaille. Deshalb legen wir bei der Gestaltung unserer Produkte stets Wert darauf, einfach zu verwendende und leicht zu reinigende Produkte zu schaffen, die sich an den Installationsort anpassen und ansprechend sind.

Ästhetik, Materialwahl und Farben der Verkleidungsplatten werden erfahrenen Designern aus der Möbel- und Architekturwelt anvertraut, die täglich neue Trends erkunden. Unsere Produktpalette umfasst klassische Produkte mit Majolika-Verkleidung sowie moderne Formen mit farbigem Glas oder Paneele mit Carbon-, Silber- oder Wenge-Effekt und wird durch Steinzeugpaneele mit Natursteineffekt bereichert: vom Carrara-Marmor bis zu den goldenen Adern unserer Night-Modelle.

Jedes Produkt zeichnet sich durch eine einzigartige Ästhetik aus und verkörpert eine perfekte Mischung aus Design und Funktionalität.

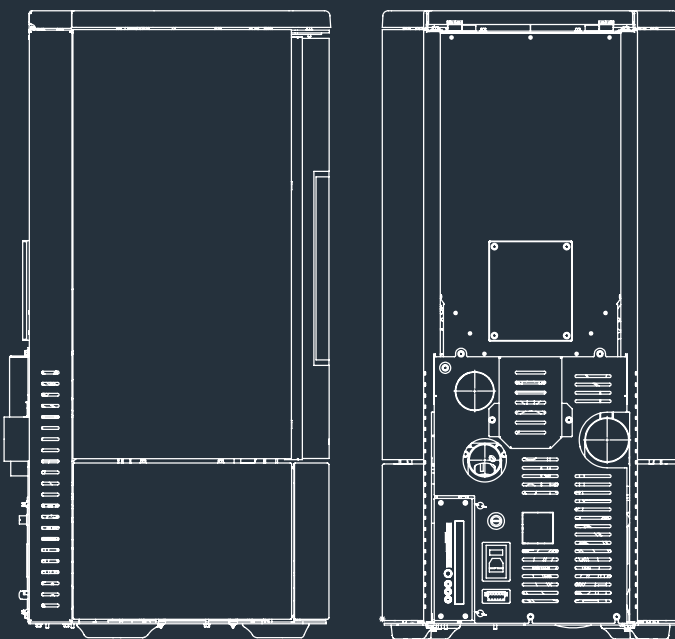



**9.000 m<sup>2</sup>**

di superficie dedicata alla  
produzione di energia pulita

Area dedicated to the production of  
clean energy

de la surface dédiée à la production  
d'énergie propre

Bereich, der der Erzeugung  
sauberer Energie gewidmet ist



**680.000 kW/anno**

picco di energia elettrica sviluppata  
da fonti rinnovabili

Yearly energy peak generated from  
renewable sources

/ année - d'électricité produite à  
partir de sources renouvelables

Jährlicher Energiehöchstwert, der  
aus erneuerbaren Quellen erzeugt  
wird



**5X**

la produzione di energia è cinque  
volte superiore al consumo

energy production is five times  
higher than power consumption

la production d'énergie est cinq  
fois supérieure à la consommation

Die Energieproduktion ist fünfmal  
höher als der Stromverbrauch

simply  
**NEUTRAL**

**nobis**

## Semplicemente neutrale

Lavorare insieme per un mondo sostenibile è fatto di gesti concreti.

Il nostro impegno per ridurre l'impatto delle nostre abitudini sull'ambiente non si limita alla progettazione e produzione di prodotti con alte prestazioni energetiche, ridotti consumi ed emissioni, ma coinvolge il nostro intero processo produttivo.

Ne è dimostrazione la scelta di installare sulle coperture della produzione un impianto fotovoltaico in grado di produrre fino a 680kW, oltre 5 volte l'energia elettrica che la nostra attività consuma.

L'intero ciclo produttivo non è quindi solo neutrale, ma è addirittura a saldo positivo: produciamo ogni giorno fino a 5 kW di energia per ogni kW consumato.

## Simply neutral

Working together for a sustainable world is a matter of concrete actions.

Our commitment to reducing the environmental impact of our habits is not limited to designing and manufacturing energy efficient products, but it is a process which encompasses our production on the whole.

Proof of this is our decision to install a photovoltaic system on the roofs of our production facilities which is capable of generating up to 680kW, that is, more than 5 times the electrical energy we normally consume.

Therefore, the whole production cycle is not only neutral, but positive, for this means that we produce up to 5kW of energy for every kW consumed every day.

## Tout simplement, neutre

Pour un monde durable, des gestes concrets sont nécessaires.

Notre engagement à réduire l'impact de nos habitudes sur l'environnement ne se limite pas à la conception et à la production de produits à haute performance énergétique, à faible consommation et émissions, mais concerne également l'ensemble de notre processus de production.

Ceci est démontré par le fait que nous avons décidé d'installer un système photovoltaïque capable de produire jusqu'à 680kW, soit plus de 5 fois l'électricité que consomme notre activité, sur les toits du département Production.

L'ensemble du cycle de production est donc non seulement neutre, mais même avec un bilan positif : nous produisons jusqu'à 5 kW par jour d'énergie pour chaque kW consommé.

## Einfach neutral

Die Zusammenarbeit für eine nachhaltige Welt ist eine Frage konkreter Maßnahmen.

Unser Engagement zur Reduzierung der Umweltauswirkungen unserer Gewohnheiten beschränkt sich nicht nur auf die Entwicklung und Herstellung energieeffizienter Produkte, sondern ist ein Prozess, der unsere gesamte Produktion umfasst.

Ein Beweis dafür ist unsere Entscheidung, auf den Dächern unserer Produktionsanlagen eine Photovoltaikanlage zu installieren, die bis zu 680 kW erzeugen kann, also mehr als das Fünffache der elektrischen Energie, die wir normalerweise verbrauchen.

Daher ist der gesamte Produktionszyklus nicht nur neutral, sondern auch positiv, denn das bedeutet, dass wir für jedes verbrauchte kW täglich bis zu 5 kW Energie produzieren.



Il nostro braciere è di serie su:  
 Our brazier is installed as standard on:  
 Notre brasier est standard sur:  
 Unsere Feuerschale wird standardmäßig installiert auf:



**STUFE BI-FUEL**  
 DUAL-FUEL STOVES  
 POÊLES À DOUBLE COMBUSTIBLE  
 DUAL-FUEL-HERD



**STUFE IBRIDE**  
 HYBRID STOVES  
 HYBRIDES  
 HYBRIDÖFEN



**STUFE ARIA**  
 AIR STOVES  
 POÊLES À AIR  
 LUFTÖFEN



**STUFE ACQUA**  
 THERMOSTOVES  
 THERMOPOÊLES  
 THERMOÖFEN



**CAMINI A PELLETT**  
 INSERTS  
 CHEMINÉES  
 EINLAGEN



**CALDAIE**  
 BOILERS  
 CHAUDIÈRES  
 KESSEL

## Il braciere originale, semplicemente Nobis

L'innovativo braciere Nobis garantisce la pulizia automatica continua senza operazioni manuali e interviene non ad intervalli regolari -come la gran parte dei sistemi presenti sul mercato- ma solamente in caso di reale necessità. In soli 15 minuti la stufa si spegne, si pulisce e si riaccende

in autonomia, evitando il raffreddamento degli scambiatori.

Il nostro software **Elemento** decide il momento più opportuno per effettuare il ciclo di pulizia, solo quando ce n'è veramente bisogno.

## The original brazier, simply Nobis

Our innovative brazier ensures continuous automatic cleaning without need for manual operations. Moreover, it does not activate at regular intervals - as most systems on the market do - but only when really necessary. The stove switches off, cleans itself and switches back on again automatically in just 15 minutes,

thus preventing heat exchangers from cooling down.

Our software **Elemento** will take care of choosing the best time to carry out cleaning, doing it only in real case of necessity.



## Le brasier original, tout simplement Nobis

L'innovant brasier Nobis garantit un nettoyage automatique continu, sans avoir besoin d'opérations manuelles. Il n'intervient pas à intervalles réguliers, comme la plupart des systèmes du marché, mais seulement si vraiment nécessaire. En seulement 15 minutes, le poêle s'éteint, se nettoie et se rallume

de manière autonome, évitant le refroidissement des échangeurs.

Notre logiciel **Elemento** est capable de comprendre quand il est vraiment nécessaire d'exécuter le cycle de nettoyage.

## Die echte Kohlenpfanne, einfach Nobis

Unsere innovative Feuerschale gewährleistet eine kontinuierliche automatische Reinigung, ohne dass manuelle Eingriffe erforderlich sind. Darüber hinaus wird sie nicht in regelmäßigen Abständen aktiviert, wie dies bei den meisten Systemen auf dem Markt der Fall ist, sondern nur dann, wenn es wirklich notwendig ist. Der Ofen schaltet sich aus, reinigt sich selbst und schaltet

sich automatisch wieder ein. Die Reinigung erfolgt in nur 15 Minuten und verhindert so ein Abkühlen der Wärmetauscher.

Unsere Software **Elemento** kümmert sich darum, den besten Zeitpunkt für die Reinigung auszuwählen und führt die Reinigung nur im wirklichen Bedarfsfall durch.



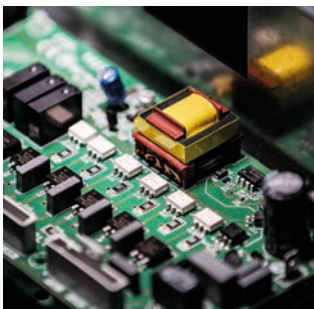

## La nostra ricerca semplicemente avanti

Il reparto di ricerca e sviluppo è il cuore pulsante della nostra attività. Sviluppa e implementa ogni giorno nuove soluzioni tecniche, a partire dalle richieste del mercato, le indicazioni dei clienti e le nuove tecnologie a disposizione. Le logiche di funzionamento, i processi, la componentistica, sono progettate per rispondere in modo concreto alla richiesta di prodotti versatili, resistenti nel tempo, sicuri, autonomi e rispettosi dell'ambiente.

## Our research, simply advanced

Our R&D department is the beating heart of our business; it develops and implements new technical solutions on a daily basis, starting with an assessment of market demand to encompass customer feedback and the analysis of the new technologies available. The operating logic, processes, and components are geared towards the creation of versatile products that are resistant over time, safe, automatic, and environmentally friendly.

## Nos recherches, tout simplement avancées

Notre département R&D est le cœur battant de notre activité ; il développe et met en œuvre au quotidien de nouvelles solutions techniques, en commençant par une évaluation de la demande du marché intégrant les retours des clients et l'analyse des nouvelles technologies disponibles. La logique de fonctionnement, les processus et les composants sont orientés vers la création de produits polyvalents, résistants dans le temps, sûrs, automatiques et respectueux de l'environnement.

## Unsere Forschung einfach fortgeschritten

Die Forschungs- und Entwicklungsabteilung ist das schlagende Herz unseres Unternehmens. Sie entwickelt und implementiert täglich neue technische Lösungen, ausgehend von Marktanforderungen, Kundenindikationen und den neuen verfügbaren Technologien. Die Betriebslogiken, Prozesse und Komponenten sind darauf ausgelegt, konkret auf die Nachfrage nach vielseitigen, langlebigen, sicheren, autonomen und umweltfreundlichen Produkten zu reagieren.

 **clean**  
AUTOMATIC BRAZIER

 **perfect**  
OPTIMIZE COMBUSTION

 **connect**  
EVERYWHERE AND EVERYWHEN

 **timeless**  
LONG-LASTING MATERIALS

 **silent**  
BRUSHLESS TECHNOLOGY

 **shine**  
TRANSPARENT GLASS

 **save**  
PELLET OPTIMIZER



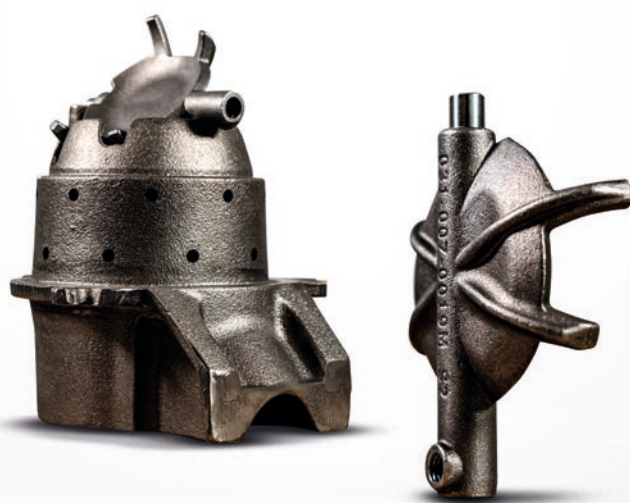

SCAN ME

## Il fuoco nuovo, semplicemente pulito

L'innovativo sistema di pulizia automatica di Nobis garantisce un funzionamento continuo senza operazioni manuali fino a 40 giorni di utilizzo, intervenendo solamente in caso di reale necessità.

In soli 15 minuti la stufa si spegne, si pulisce e si riaccende

in maniera completamente automatica evitando il raffreddamento degli scambiatori.

**Elemento** monitora il funzionamento e decide il momento corretto per effettuare il ciclo di pulizia.

## A new fire, simply clean

Nobis' innovative automatic cleaning system guarantees continuous operation with no need for manual intervention, even after prolonged use, intervening only when really needed.

In just 15 minutes, the stove switches off, cleans itself and

re-ignites automatically, thus preventing heat exchangers from cooling down.

**Elemento** monitors the operation and chooses the right time to perform the cleaning cycle.

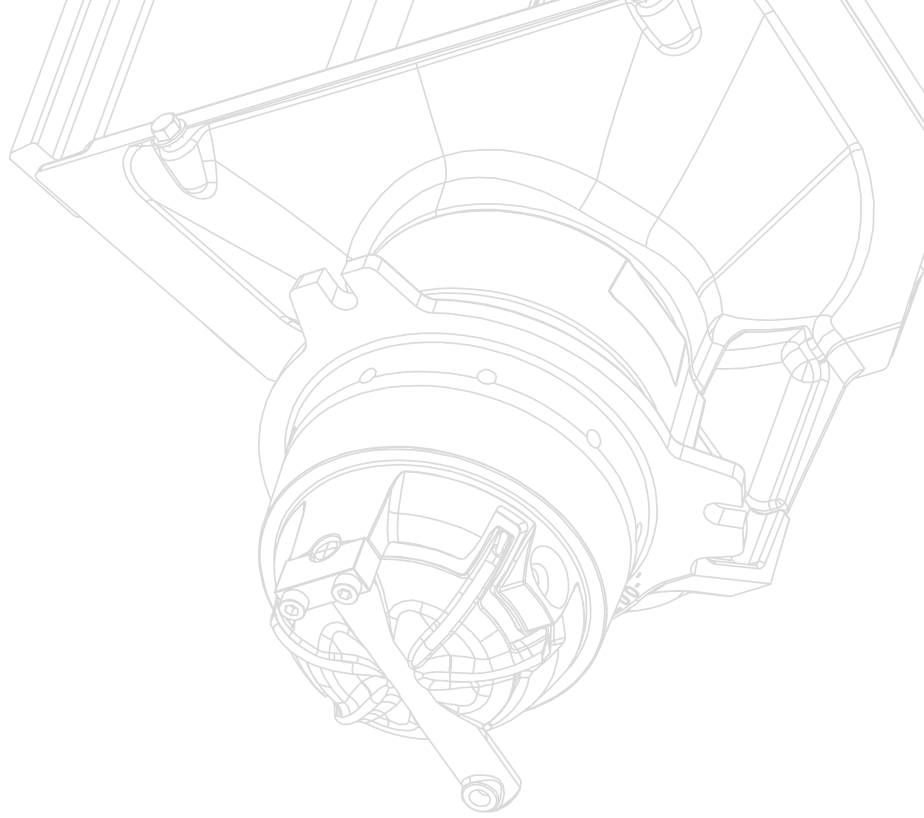

**1**  
Accensione  
Ignition  
Allumage  
Zündung



**2**  
Spegnimento  
Switch-off  
Arrêt  
Ausschalten



**3**  
Pulizia  
Cleaning  
Nettoyage  
Reinigung



**4**  
Caricamento  
Loading  
Chargement  
Laden



**5**  
Riaccensione  
Re-ignition  
Rallumage  
Wiederzündung

## Un nouveau feu, tout simplement propre

Le système de nettoyage automatique innovant de Nobis garantit un fonctionnement continu sans opération manuelle, pendant longtemps. Il n'intervient pas à des intervalles programmés comme chez la plupart des systèmes disponibles sur le marché, mais uniquement en cas de réelle nécessité.

En seulement 15 minutes, le poêle s'éteint, se nettoie et se rallume automatiquement, évitant ainsi le refroidissement des échangeurs.

'Elemento' surveille le fonctionnement et décide le meilleur moment pour effectuer le cycle de nettoyage.

## Das neue Feuer, einfach sauber

Das innovative automatische Reinigungssystem von Nobis garantiert einen kontinuierlichen Betrieb ohne manuelles Eingreifen auch nach längerem Gebrauch und greift nur dann ein, wenn es wirklich nötig ist.

In nur 15 Minuten schaltet sich der Ofen ab, reinigt sich selbst und zündet automatisch wieder

und verhindert so ein Auskühlen der Wärmetauscher.

'Elemento' überwacht den Vorgang und wählt den richtigen Zeitpunkt für die Durchführung des Reinigungszyklus.

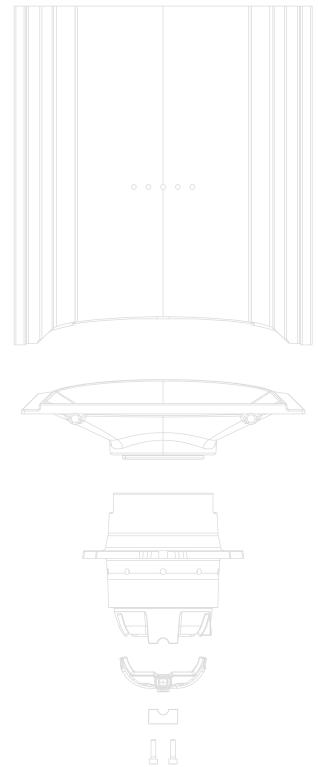

## La fiamma nuova, semplicemente perfetta

Il nuovo braciere e il nuovo corpo stufa hanno permesso di ottenere una combustione unica nel suo genere.

Il braciere resta sempre pulito grazie al sistema di pulizia automatica, la fiamma mantiene una forma perfetta grazie alla gestione dei flussi dell'aria

comburente e la visione della fiamma è ottimale grazie al sistema di pulizia del vetro e al caricamento nascosto.

Il sistema Perfect permette di utilizzare la maggior parte dei tipi di pellet in commercio in quanto garantisce una taratura automatica della combustione.

## A new flame, simply perfect

Our new brazier and stove body have resulted in unique combustion.

Thanks to the special automatic-cleaning system, the brazier is kept clean over time. Moreover, the flame is always sharp and crisp thanks to the combustion-air management system. Finally, the glass cleaning system and

hidden loading allow you to enjoy a perfect view of the flame.

Also, a special feature allows for auto-calibration of the combustion parameters to make our Perfect system compatible with most types of pellets available on the market.

## Une nouvelle flamme, tout simplement parfaite

Le nouveau brasier et le nouveau corps du poêle permettent une combustion unique en son genre.

Le brasier reste propre à tout moment grâce au système de nettoyage automatique, la flamme conserve une forme parfaite grâce à la gestion des flux d'air de combustion et la

vision de la flamme est optimale grâce au système de nettoyage de la vitre et au chargement caché.

Le système Perfect permet d'utiliser la plupart des types de granulés disponibles sur le marché et garantit un étalonnage automatique de la combustion.

## Die neue Flamme, einfach perfekt

Unsere neue Brennschale und der Ofenkörper haben zu einer einzigartigen Verbrennung geführt.

Dank des speziellen automatischen Reinigungssystems bleibt die Brennschale im Laufe der Zeit sauber. Darüber hinaus ist die Flamme dank des Verbrennungsluftmanagementsystems immer scharf und klar.

Schließlich ermöglichen das Glasreinigungssystem und die versteckte Beladung Ihnen eine perfekte Sicht auf die Flamme.

Eine besondere Funktion ermöglicht außerdem die automatische Kalibrierung der Verbrennungsparameter, um unser Perfect-System mit den meisten auf dem Markt erhältlichen Pellettypen kompatibel zu machen.

Camera di combustione in vermiculite

*Vermiculite combustion chamber / Descente cendres / Vermiculit-Brennkammer*

Scivolo Ceneri

*Ash slide / Descente cendres / Ascherutsche*

Concentratore

*Concentrator / Concentrateur / Konzentrator*

Aria primaria

*Primary air / Air primaire / Primärluft*

Corpo in ghisa in fusione unica

*One-piece cast iron body / Corps en fonte d'une seule piece / Eintelliger Gusskörper*

Aria secondaria

*Secondary air / Air secondaire / Sekundärluft*

Fondello girevole autopulente

*Self-cleaning rotating plate / Fond tournant autonettoyant / Selbstreinigender Drehteller*



SCAN ME



**Motoriduttore brushless**  
*Brushless gear motor / Motoréducteur sans balais / Bürstenloser Getriebemotor*

## Il caricamento brushless, semplicemente silenzioso

Il caricamento del pellet avviene tramite un motoriduttore brushless che non ha bisogno di contatti elettrici striscianti sull'albero del rotore e la commutazione della corrente circolante negli avvolgimenti dello statore avviene elettronicamente. Ciò comporta una minore resistenza meccanica e riduce notevolmente la manutenzione e la rumorosità, proprio perché non avvengono sfregamenti fisici. La conformazione del braciere permette di utilizzare una bassa velocità del motore di aspirazione contribuendo a

un alto comfort acustico, così come la scelta delle ventole e il dimensionamento dei canali di passaggio dell'aria garantiscono la massima silenziosità anche quando la stufa funziona in regime di ventilazione. Gli scambiatori in ghisa hanno una particolare conformazione che sfrutta il principio dell'effetto Venturi e generano un aumento della velocità dell'aria senza la ventilazione forzata. In questo modo è stato interpretato al meglio il moto convettivo dell'aria, garantendone un'ottima velocità in assenza di fastidiosi fruscii.

## Brushless loading, simply silent

Pellet-loading operations are carried out by means of a brushless gearmotor which does not need for any sliding electrical contacts on the rotor shaft. Also, current switching in the stator windings is controlled electronically. This implies lesser mechanical resistance, resulting in a significant reduction of both noise and maintenance, as no physical friction occurs. Also, the particular structure of the brazier (which allows the vacuum motor to work at low speed), the shape of the fans and the size of the air ducts help

enhance acoustic comfort even further, thus ensuring utmost silence even when the stove is operating in ventilation mode. Moreover, the cast-iron heat exchangers have been conceived so as to exploit the Venturi effect to increase air speed without forced ventilation. In this way, you will be able to get the best out of the stove's air convection system, for optimized air speed without annoying noises.

## Chargement sans balais, tout simplement silencieux

Les granulés sont chargés par un motoréducteur sans balais. Contrairement aux moteurs à balais, des contacts électriques glissants (balais) ne sont pas nécessaires sur l'arbre du rotor pour fonctionner et la commutation du courant circulant dans les enroulements du stator se fait électroniquement. Cela entraîne une résistance mécanique plus faible, ce qui réduit considérablement le besoin d'entretien périodique et le bruit, étant donné qu'aucun frottement physique ne se produit. La conformation du brasier permet d'utiliser une faible vitesse du moteur d'aspiration contribuant à

un confort élevé acoustique, ainsi que le choix des ventilateurs et du dimensionnement des canaux de passage de l'air, qui garantissent un silence maximal même lorsque le poêle fonctionne en mode ventilation. Les échangeurs en fonte ont une conformation particulière qui exploite le principe de l'effet Venturi et génère une augmentation de la vitesse de l'air sans nécessiter de ventilation forcée. De cette façon, le mouvement convectif de l'air a été interprété de la meilleure façon possible, garantissant une excellente vitesse, en l'absence de bruissements gênants.

## Bürstenloses Laden, einfach still

Die Pelletbeladung erfolgt über einen bürstenlosen Getriebemotor, der keine elektrischen Schleifkontakte auf der Rotorwelle benötigt. Außerdem wird die Stromumschaltung in den Statorwicklungen elektronisch gesteuert. Dies bedeutet einen geringeren mechanischen Widerstand, was zu einer deutlichen Reduzierung führt Geräusch- und wartungsarm, da keine physikalische Reibung auftritt. Auch die besondere Struktur der Brennschale (die es dem Vakuummotor ermöglicht, bei niedriger Geschwindigkeit zu arbeiten), die Form der

Ventilatoren und die Größe der Luftkanäle tragen dazu bei, den akustischen Komfort noch weiter zu steigern und so höchste Geräuschlosigkeit auch bei Betrieb des Ofens im Lüftungsmodus zu gewährleisten. Darüber hinaus wurden die gusseisernen Wärmetauscher so konzipiert, dass sie den Venturi-Effekt nutzen, um die Luftgeschwindigkeit ohne Zwangslüftung zu erhöhen. Auf diese Weise können Sie um das Luftkonvektionssystem des Ofens optimal zu nutzen und die Luftgeschwindigkeit ohne störende Geräusche zu optimieren.

Convezione naturale

*Natural convection / Convection naturelle / Natürliche Konvektion*

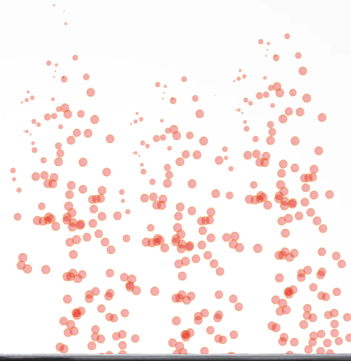

Ventilazione frontale escludibile

*Optional front ventilation /  
Ventilation avant excluable /  
Optionale Frontbelüftung*





**timeless**  
LONG-LASTING MATERIALS



## Materiali scelti per durare nel tempo

Il corpo stufa è realizzato con materiali certificati ad alto spessore. La saldatura è completamente robotizzata, in modo da garantire una qualità e una durata costante nel tempo. Ogni corpo stufa viene

controllato a fine linea tramite un test di ermeticità che garantisce la qualità della saldatura. Gli scambiatori in ghisa e il braciere ad alto spessore garantiscono una lunga durata nel tempo.

## Materials chosen to last over time

The stove body is made with high-thickness, certified materials. Welding is completely robotized, so as to guarantee quality over time. The hermetic seal of every stove body is

checked at the end of the production line. Thick cast-iron heat exchangers and a high-thickness brazier ensure durability over time.

## Matériaux choisis pour durer dans le temps

Le corps du poêle est fabriqué avec des matériaux certifiés de haute épaisseur. La soudure est entièrement robotisée, afin de garantir une qualité et une durée constantes dans le temps. Chaque corps de poêle

est contrôlé en fin de ligne au moyen d'un test d'étanchéité qui garantit la qualité de la soudure. Les échangeurs en fonte et le brasier épais garantissent une longue durée de vie.

## Materialien, die für eine lange Lebensdauer ausgewählt wurden

Der Ofenkörper besteht aus zertifizierten Materialien mit hoher Dicke. Das Schweißen erfolgt vollständig robotisiert, um die Qualität langfristig zu gewährleisten. Die hermetische Abdichtung jedes

Ofenkörpers wird am Ende der Produktionslinie überprüft. Dicke Gusseisen-Wärmetauscher und eine Brennschale mit hoher Dicke gewährleistet eine lange Haltbarkeit.

Scambiatori in ghisa con effetto Venturi

*Cast-iron heat exchanger (Venturi effect) /  
échangeurs en fonte avec effet Venturi /  
Gusseiserner Wärmetauscher (Venturi-Effekt)*

Corpo ad alto spessore

*High-thickness body / Corps forte épaisseur /  
Körper mit hoher Dicke*

Saldatura robotizzata

*Robotized welding / Soudure robotisé /  
Roboterisiertes Schweißen*





## Di serie sempre, su tutte le stufe

La nostra tecnologia Connect permette il controllo delle stufe attraverso l'applicazione Nobis-Fi, disponibile su App store e Google Play. Il modulo wi-fi è installato di serie su quasi tutti i nostri prodotti, e permette la gestione della stufa

da remoto, con il monitoraggio dello stato e controllo dei valori. Inoltre è possibile impostare le funzionalità del cronotermostato. La libertà di scegliere e gestire il calore preferito non ha più confini di tempo e di spazio.

## Always standard, on all stoves

Our Connect technology allows you to manage the stoves through the Nobis-Fi app, available on App store and Google Play. A Wi-Fi module is installed as standard on almost all our products, to allow for remote management

and monitoring, as well as thermostat programming. Enjoy the freedom to choose, manage and get the most out of your heating system, with no more boundaries of space or time.

## Toujours standard, sur tous le poêles

Notre technologie Connect permet le contrôle des poêles via l'application Nobis-Fi, disponible sur l'App Store et Google Play. L'appareil Wi-Fi est installée en standard sur la quasi-totalité de nos produits et permet la gestion à distance

du poêle, la surveillance de l'état et le contrôle de la valeur. Il est également possible de paramétrer les fonctions du chronothermostat. La liberté de choisir et de gérer la température préférée n'a pas de limites de temps et d'espace.

## Immer serienmäßig, auf allen Herden

Mit unserer Connect-Technologie können Sie die Öfen über die Nobis-Fi-App verwalten, die im App Store und bei Google Play verfügbar ist. Bei fast allen unseren Produkten ist standardmäßig ein Wi-Fi-Modul installiert, das die Fernverwaltung und

-überwachung sowie die Thermostatprogrammierung ermöglicht. Genießen Sie die Freiheit, Ihr Heizsystem auszuwählen, zu verwalten und das Beste aus ihm herauszuholen, ohne räumliche oder zeitliche Grenzen mehr.



#### CONTROLLO REMOTO

L'applicazione Nobis-Fi permette l'accensione, lo spegnimento e la regolazione della ventilazione anche quando non si è in casa tramite la rete wifi.

#### CRONOTERMOSTATO

Personalizzare la stufa non è mai stato così semplice: in pochi secondi è possibile inserire fino a quattro programmazioni e gestire orari di accensione e spegnimento, temperatura, potenza e ventilazioni su uno o più giorni della settimana.

#### GESTIONE MULTI-DISPOSITIVO

Da un'unica applicazione è possibile gestire più dispositivi e programmare parametri e programmazioni in modo indipendente, via wi-fi o bluetooth.

#### TÉLÉCOMMANDE

L'application Nobis-Fi vous permet d'allumer, d'éteindre et de régler la ventilation même lorsque vous n'êtes pas chez vous, grâce au réseau WiFi.

#### CHRONOTHERMOSTAT

Personnaliser le poêle n'a jamais été aussi simple : en quelques secondes, il est possible d'entrer jusqu'à quatre programmes et de gérer les temps de allumage et extinction, température, puissance et ventilation pour un ou plusieurs jours de la semaine.

#### GESTION MULTI-APPAREILS

À partir d'une seule application, il est possible de gérer plusieurs appareils et de programmer les paramètres et les horaires indépendamment, via Wi-Fi ou Bluetooth.

#### REMOTE CONTROL

Nobis-Fi is an application which allows you to switch the product on and off and to adjust ventilation remotely, even when you are not at home, thanks to its WiFi network.

#### PROGRAMMABLE THERMOSTAT

Customizing your stove has never been easier: enter up to four timer programs in just a few seconds and manage switch-on and switch-off hours, temperature, power and ventilation, for one or more days of the week.

#### MULTI-DEVICE MANAGEMENT

Take advantage of WiFi or Bluetooth technology to manage several devices from one single application, to adjust parameters and set schedules independently.

#### FERNBEDIENUNG

Nobis-Fi ist eine Anwendung, mit der Sie das Produkt dank seines WiFi-Netzwerks aus der Ferne ein- und ausschalten und die Belüftung regulieren können, auch wenn Sie nicht zu Hause sind.

#### PROGRAMMIERBARER THERMOSTAT

Die individuelle Gestaltung Ihres Ofens war noch nie so einfach: Geben Sie in wenigen Sekunden bis zu vier Zeitprogramme ein und verwalten Sie Ein- und Ausschaltstunden, Temperatur, Leistung und Belüftung für einen oder mehrere Wochentage.

#### VERWALTUNG MEHRERER GERÄTE

Nutzen Sie die WiFi- oder Bluetooth-Technologie, um mehrere Geräte über eine einzige Anwendung zu verwalten, Parameter anzupassen und Zeitpläne unabhängig festzulegen.



## Il fuoco nuovo, semplicemente visibile

Due condotti di aria indipendenti posizionati nella camera di combustione creano una membrana protettiva tra il vetro e la fiamma che permette di allontanare i residui di

combustione dal vetro e lo mantiene sempre pulito, anche dopo molte ore di utilizzo, per una visione della fiamma sempre chiara e nitida.

## The new fire, simply visible

Two independent air ducts are installed in the combustion chamber to create a protective membrane between the glass and the flame. This helps keep combustion residue away

from the glass. As a result, the doorpane remains clean even after prolonged use, so you can enjoy the view of the flame to the full.

## Un feu nouveau, tout simplement visible

Deux conduits d'air indépendants, positionnés dans la chambre de combustion, créent une membrane protectrice entre la vitre et la flamme. Cela permet d'éliminer les résidus de

combustion du verre et de le garder toujours propre, même après de nombreuses heures d'utilisation, pour une vision toujours claire et nette de la flamme.

## Das neue Feuer, einfach sichtbar

In der Brennkammer sind zwei unabhängige Luftkanäle installiert, die eine schützende Membran zwischen Glas und Flamme bilden. Dadurch werden Verbrennungsrückstände vom

Glas ferngehalten. Dadurch bleibt die Türscheibe auch nach längerem Gebrauch sauber, sodass Sie den Blick auf die Flamme in vollen Zügen genießen können.

Immissione dell'aria tra vetro e fiamma

---

*Airflow between glass and flame /  
Flux d'air entre le verre et la flamme /  
Lufteinleitung zwischen Glas und Flamme*

Membrana protettiva mantiene il vetro pulito a lungo

---

*A protective air membrane keeps  
the glass clean for a long time /  
Une membrane d'air protectrice maintient  
le verre propre pendant longtemps /  
Die Luftschutzmembran hält  
das Glas lange sauber*



Condotto indipendente d'aria

---

*Independent air duct /  
Conduit d'air indépendant /  
Unabhängiger Luftkanal*

## Il fuoco nuovo, senza sprechi

Il software Elemento regola in modo continuo le variazioni di carico causate dalle diverse tipologie di pellet. Il software controlla inoltre la temperatura dello scambiatore di calore tramite la sonda K e J, posizionate nella parte

alta e bassa degli scambiatori. Il continuo controllo sulla temperatura garantisce che lo scambiatore di calore abbia un rendimento costante al 100%, senza sprechi di calore e di combustibile.

## A new fire, without waste

Elemento is a software which continuously adjusts load variations caused by the different types of pellets employed. Moreover, it monitors the temperature of the heat exchanger via probes K and J, respectively located at

the top and bottom of the heat exchangers. Constant monitoring of temperature ensures that the heat exchanger operates consistently and with maximum efficiency, without waste of fuel or heat dissipation.

## Un feu nouveau, sans déchets

Le logiciel Elemento ajuste en permanence les variations de charge provoquées par les différents types de pellets. Le logiciel contrôle également la température de l'échangeur via les sondes K et J (positionnés respectivement en partie haute

et basse des échangeurs). Le contrôle constant de la température garantit que l'échangeur de chaleur a une efficacité constante de 100 %, sans gaspillage de chaleur ou de carburant.

## Ein neues Feuer, ohne Verschwendung

Elemento ist eine Software, die Belastungsschwankungen, die durch die verschiedenen verwendeten Pelletarten verursacht werden, kontinuierlich anpasst. Darüber hinaus überwacht sie die Temperatur des Wärmetauschers über die Sonden

K und J, die sich jeweils oben und unten am Wärmetauscher befinden. Ständige Überwachung der Temperatur stellt sicher, dass der Wärmetauscher konstant und mit maximaler Effizienz arbeitet, ohne Kraftstoffverschwendung oder Wärmeableitung.



↓ 20%

Regolazione continua della  
variazione del carico

Continuous load adjustments

Ajustements continus du  
chargement

Stufenlose Anpassung der  
Beladungsvariation

Riduzione fino al 20%\* del  
consumo di pellet.

Reduction of up to 20%\* in  
pellet consumption.

Réduction jusqu'à 20%\* de la  
consommation de granulés.

Reduzierung des  
Pelletverbrauchs um  
bis zu 20%\*.



**SONDA K**  
*PROBEK / LA SONDEK / SONDEK*

Misura la temperatura della  
fiamma prima che il calore  
attraversi lo scambiatore.

It measures the temperature of the  
flame before heat radiates through  
the exchanger.

La sonde mesure la température  
de la flamme avant que la chaleur  
ne traverse l'échangeur.

Es misst die Temperatur der  
Flamme, bevor Wärme durch den  
Wärmetauscher strahlt.



**SONDA J**  
*PROBE J / LA SONDE J / SONDE J*

Misura la temperatura dei fumi  
dopo aver ceduto il calore allo  
scambiatore di calore.

It measures the temperature  
of exhaust smoke after the  
exchanger is heated.

La sonde mesure la température  
des fumées après avoir transféré la  
chaleur à l'échangeur.

Es misst die Temperatur des  
Abgasrauchs nach der Erwärmung  
des Wärmetauschers.

\* Dato da test effettuati sullo stesso modello di stufa in ambiente domestico e estratto da consumo domestico di pellet su base annua.

\* Data collected from the analysis of the same stove model in a domestic environment and calculated on the basis of the quantity of pellets consumed over a year.

\* Données collectées à partir de l'analyse du même modèle de poêle en milieu domestique et calculées sur la base de la quantité de granulés consommée sur une année.

\* Die Daten wurden mit demselben Ofenmodell in einer häuslichen Umgebung ermittelt und auf jährlicher Basis aus dem häuslichen Pelletverbrauch errechnet.



STUFE ARIA | AIR STOVES | POÊLES À AIR | AIR-LUFTÖFEN



**ARIA**  
LA FORZA DELL'ARIA

## Convezione naturale

*Natural convection / Convection naturelle / Natürliche Konvektion*

Scambiatori in ghisa con conformazione che sfrutta l'effetto venturi: massimo silenzio e flusso d'aria naturale senza sollevare polveri fastidiose.

Cast-iron heat exchangers specifically designed to exploit the Venturi effect: utmost silence and natural airflow without lifting annoying dust.

Échangeurs de chaleur en fonte spécialement conçus pour exploiter l'effet Venturi : silence maximal et flux d'air naturel sans soulèvement de poussières ennuyeux.

Gusseiserne Wärmetauscher, die speziell für die Ausnutzung des Venturi-Effekts entwickelt wurden: höchste Geräuschlosigkeit und natürlicher Luftstrom, ohne störenden Staub aufzuwirbeln.

## Ventilazione

*Ventilation / Ventilation / Belüftung*

Ventilazione forzata completamente escludibile per un calore immediato e diffuso nell'ambiente di installazione.

Forced ventilation can be activated to heat the room immediately.

L'utilisateur a la possibilité d'activer la ventilation forcée pour une chaleur immédiate et diffuse dans l'environnement de l'installation.

Um den Raum sofort zu heizen, kann eine Zwangsbelüftung aktiviert werden.

## Canalizzazione Ø60 o Ø80mm

*Canalization Ø60 or Ø80mm / Canalisation Ø60 ou Ø80mm / Kanalisation Ø60 oder Ø80mm*

Singola o doppia fino a 8 metri, di serie o con kit opzionale, per riscaldare due o più ambienti in modo autonomo e differenziato.

Single or double, up to 8 meters, as standard or as optional kit, to heat two or more rooms autonomously and independently.

Simple ou double, jusqu'à 8 mètres, en standard ou en kit en option, pour chauffer deux ou plusieurs pièces de manière autonome et indépendante.

Einzel- oder Doppelheizung, bis zu 8 Meter, als Standard- oder optionaler Bausatz, um zwei oder mehr Räume autonom und unabhängig zu heizen.



## Telecomando con funzione termostato

*Remote control equipped with room thermostat function / Télécommande équipée de la fonction de thermostat / Fernbedienung mit Raumthermostatfunktion ausgestattet*

Telecomando touch con funzione di termostato ambiente. Immediato e intuitivo, comanda in modo semplice la tua stufa. Tutto a portata di touch.

Touch remote control equipped with room thermostat function. User-friendly, to easily control your stove. Everything at your fingertips.

Télécommande tactile équipée de la fonction de thermostat d'ambiance. Facile à utiliser, pour contrôler facilement votre poêle. Tout à portée de main

Touch-Fernbedienung mit Raumthermostatfunktion. Benutzerfreundlich, zur einfachen Steuerung Ihres Ofens. Alles immer zur Hand.

FREE TO CHOOSE

# HYBRID BI-FUEL



Scegli come combinare pellet e legna in un prodotto solo. Il tuo modo di essere libero.

Choose how to combine pellets and wood in a single product. Your way of being free.

Choisissez comment combiner les granulés et le bois en un seul produit. Votre façon d'être libre.

Wählen Sie, wie Sie Pellets und Holz in einem einzigen Produkt kombinieren möchten. Deine Art, frei zu sein.



La stufa ibrida semplicemente **unica**.



La stufa bi-fuel semplicemente **libera**.



## La tua scelta, semplicemente **moderna**

Crediamo nella libertà totale di scegliere tra pellet e legna. Per questo abbiamo sviluppato il concetto di ibrido e di bi-fuel, due modi differenti di vivere il riscaldamento della tua casa: l'ibrido di Unica gestisce automaticamente il passaggio

tra pellet e legna e viceversa. La stufa bi-fuel Libera, invece, ha un'impostazione manuale e sei tu a scegliere il combustibile che preferisci in base all'atmosfera della tua abitazione e alle condizioni del mercato.

## Votre choix, simplement **moderne**

Nous pensons que dans le choix entre les granulés et le bois, l'utilisateur doit avoir la plus grande liberté. C'est pourquoi nous avons développé les concepts de poêles hybrides et bicomcombustible, deux manières différentes de chauffer votre maison. Notre poêle hybride Unica gère automatiquement

la transition des granulés au bois et vice versa. Le poêle bi-combustible Libera, d'autre part, est équipé d'un système de réglage manuel qui vous permet de choisir le combustible que vous préférez en fonction de votre environnement domestique et des conditions du marché.

## Your choice, simply **modern**

We believe that in the choice between pellets and wood, the user should have the greatest freedom. This is why we have developed the concepts of hybrid and dual-fuel stoves, two different ways of heating your home. Our hybrid stove Unica automatically manages the

transition from pellets to wood and vice versa. The dual-fuel stove Libera, on the other hand, is equipped with a manual setting system that allows you to choose the fuel you prefer based on your home environment and market conditions.

## Deine Entscheidung, einfach **modern**

Wir glauben an die völlige Freiheit, zwischen Pellets und Holz zu wählen. Aus diesem Grund haben wir das Hybrid- und Dual-Fuel-Konzept entwickelt. Zwei verschiedene Arten, Ihr Zuhause zu heizen: Der Unica-Hybrid verwaltet automatisch den Übergang

zwischen Pellets und Holz und umgekehrt. Der Dual-Fuel-Ofen Libera hingegen verfügt über eine manuelle Einstellung und Sie wählen den Brennstoff, den Sie bevorzugen, basierend auf der Atmosphäre Ihres Zuhauses und den Marktbedingungen.

## Un'unica camera di combustione

Only one combustion chamber

Une seule chambre de combustion

Eine einzelne Brennkammer

Funzionamento a legna  
Wood mode  
Mode bois  
Holzbefuerter Betrieb



Funzionamento a pellet  
Pellet mode  
Mode granulés de pellet  
Betrieb mit Pellets





## I vantaggi del pellet

**Pellet**  
pros

Avantages  
des **granulés**

**Pellet**  
vorteile

### IL COMFORT MODERNO

Accensione e spegnimento anche da remoto, programmazione oraria, autonomia fino a 22 ore di funzionamento continuo e pulizia automatica.

### MODERN COMFORT

Remote switching on/off, hourly programming, up to 22 hours of continuous operation, automatic cleaning.

### CONFORT MODERNE

Allumage/arrêt à distance, programmation horaire, jusqu'à 22 heures de fonctionnement continu et nettoyage automatique.

### MODERNER KOMFORT

Fernein-/ausschalten, stündliche Programmierung, bis zu 22 Stunden Dauerbetrieb, automatische Reinigung.



## I vantaggi della legna

**Wood**  
pros

Avantages  
des **bois**

**Holz**  
vorteile

### IL CALORE DELLA TRADIZIONE

La fiamma della legna, il calore delle braci, la libertà di aggiungere i ceppi come preferisci, la regolazione automatica dell'aria di combustione.

### THE WARMTH OF TRADITION

Firewood and the warmth of embers: feel free to add logs as you wish, with the convenience of automatic regulation of combustion air.

### LA CHALEUR DE LA TRADITION

La flamme du bois, la chaleur des braises, la liberté d'ajouter des bûches à volonté, le réglage automatique de l'air de combustion.

### DIE WÄRME DER TRADITION

Brennholz und die Wärme der Glut: Legen Sie nach Belieben Holzsplit nach und profitieren Sie von der komfortablen automatischen Regulierung der Verbrennungsluft.

# HYBRID

## Due alimentazioni, funzionamento automatico

Two power supplies,  
automatic operation

Deux alimentations,  
fonctionnement automatique

Zwei Zuführungen,  
Automatische Operation



Modello Unica

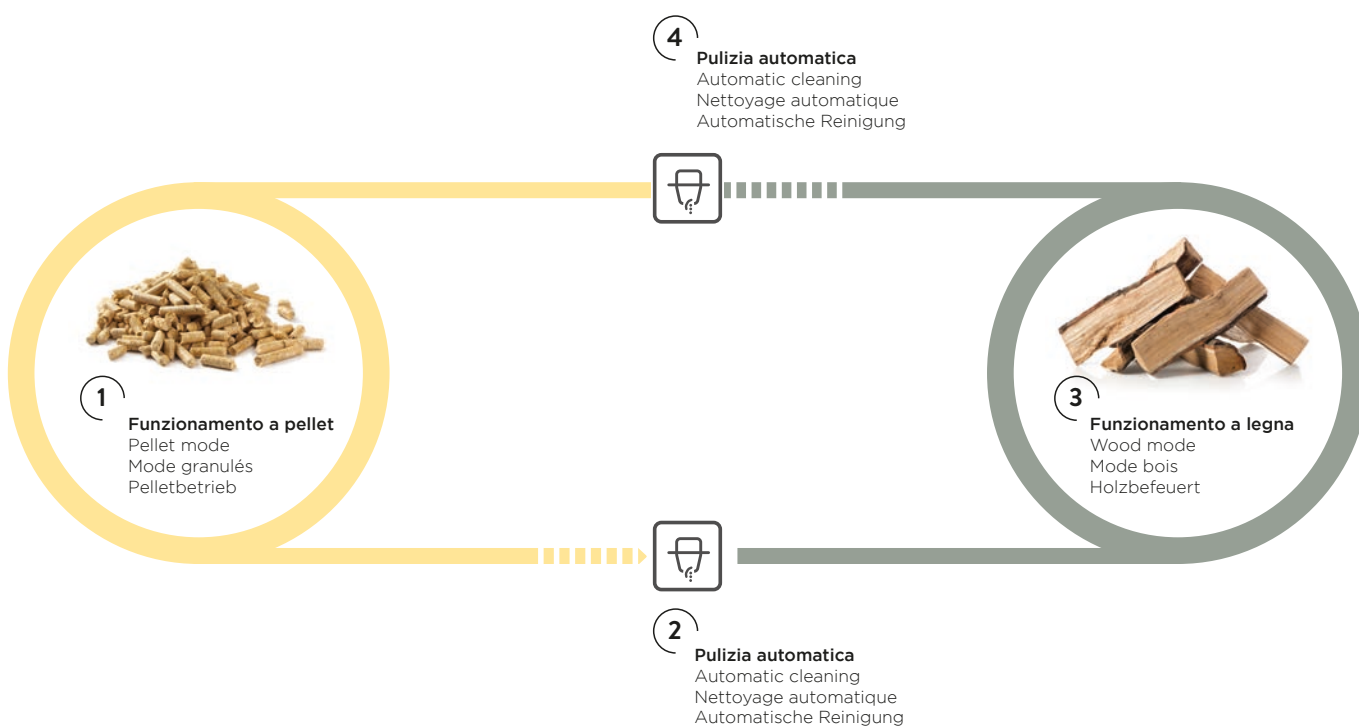

Hybrid  
**UNICA**

<b>Funzionamento a pellet</b> Pellet mode / Mode granulés / Pelletbetrieb	✓
<b>Funzionamento a legna</b> Wood mode / Mode bois / Holzbefeuert	✓
<b>Funzionamento a legna in mancanza di corrente elettrica</b> Wood-burning operation in the absence of electricity / Fonctionnement au bois en l'absence d'électricité / Holzbefeuerter Betrieb ohne Strom	✓
<b>Accensione a legna tramite il pellet</b> Wood ignition via pellets / Allumage du bois via granulés / Holzzündung mit Pellets	✓
<b>Accensione a legna manuale con accendifuoco</b> Manual wood ignition with a firelighter / Allumage manuel du bois avec un allume-feu / Manuelle Holzzündung mit Grillanzünder	✓
<b>Passaggio automatico pellet- legna</b> Automatic wood-to-pellet transition / Transition automatique des granulés au bois / Automatischer Pellet-Holz-Übergang	✓
<b>Passaggio automatico legna - pellet</b> Automatic pellet-to-wood transition / Transition automatique du bois aux granulés / Automatischer Übergang von Holz zu Pellets	✓
<b>Pulizia automatica nel ciclo a pellet</b> Automatic cleaning (pellet mode) / Nettoyage automatique (mode granulés) / Automatische Reinigung im Pelletkreislauf	✓

# BI-FUEL

## Due alimentazioni, funzionamento **manuale**

Two power supplies, manual operation

Deux alimentations, fonctionnement manuel

Zwei Zuführungen, Handbetrieb



Modello Libera

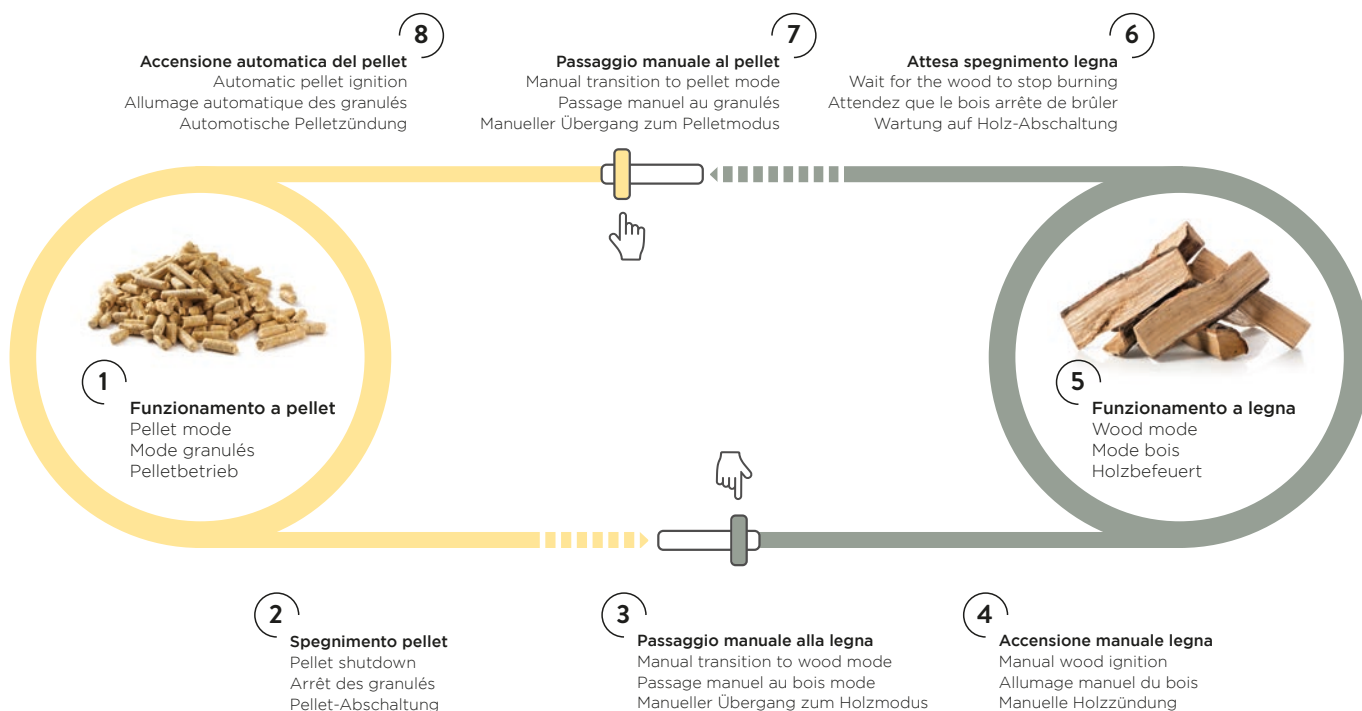

### Bi-Fuel **LIBERA**

<b>Funzionamento a pellet</b> Pellet mode / Mode granulés / Pelletbetrieb	✓
<b>Funzionamento a legna</b> Wood mode / Mode bois / Holzbefeuert	✓
<b>Funzionamento a legna in mancanza di corrente elettrica</b> Wood-burning operation in the absence of electricity / Fonctionnement au bois en l'absence d'électricité / Holzbefeuert Betrieb ohne Strom	✓
<b>Accensione a legna tramite il pellet</b> Wood ignition via pellets / Allumage du bois via granulés / Holzzündung mit Pellets	✗
<b>Accensione a legna manuale con accendifuoco</b> Manual wood ignition with a firelighter / Allumage manuel du bois avec un allume-feu / Manuelle Holzzündung mit Grillanzünder	✓
<b>Passaggio automatico pellet- legna</b> Automatic wood-to-pellet transition / Transition automatique des granulés au bois / Automatischer Pellet-Holz-Übergang	✗
<b>Passaggio automatico legna - pellet</b> Automatic pellet-to-wood transition / Transition automatique du bois aux granulés / Automatischer Übergang von Holz zu Pellets	✗
<b>Pulizia automatica nel ciclo a pellet</b> Automatic cleaning (pellet mode) / Nettoyage automatique (mode granulés) / Automatische Reinigung im Pelletkreislauf	✓



FREE TO CHOOSE

# BI-FUEL

★ PATENT PENDING



Il sistema bi-fuel: doppia alimentazione pellet e legna con funzionamento manuale.

Dual fuel system: dual fuel supply (pellet and wood) with manual operation.

Système bicombustible: alimentation bicombustible (granulés et bois) avec commande manuelle.

Das Dual-Brennstoffsystem: Doppelter Pellet- und Holzbrennstoff mit manueller Bedienung.



**La stufa bi-fuel  
semplicemente libera.**

**Bi-fuel, due alimentazioni  
funzionamento manuale**

Libera è il nostro modello di stufa bi-fuel pellet e legna in camera di combustione unica. Libera può essere usata come una moderna stufa a pellet, o una tradizionale stufa a legna. Il passaggio tra le due

alimentazioni deve essere gestito manualmente, attraverso l'impostazione di una leva posta nella parte superiore della stufa. A ogni accensione, sei tu a poter scegliere.

**Dual fuel, two power supplies,  
manual operation**

Libera (from the Italian word "free") is our dual-fuel pellet and wood stove model equipped with a single combustion chamber. Libera can be used as a modern pellet stove, or as a traditional wood stove. The

transition between the two power supplies is managed manually by adjusting a lever located in the upper part of the stove. Every time you turn it on, the choice is yours.

**Bicombustible, deux alimentations,  
fonctionnement manuel**

Libera (du mot italien « libre ») est notre modèle bicombustible à granulés et à bois équipé d'une seule chambre de combustion. Libera peut être utilisé comme poêle à granulés moderne ou comme poêle à

bois traditionnel. La transition entre les deux alimentations est gérée manuellement au moyen d'un levier situé dans la partie supérieure du poêle. Chaque fois que vous l'allumez, le choix vous appartient.

**Zwei Brennstoffe, zwei Zuführungen  
und Handbetrieb**

Libera ist unser Dual-Brennstoff-Pellet- und Holzofenmodell mit einer einzigen Brennkammer. Libera kann als moderner Pelletofen oder als traditioneller Holzofen verwendet werden. Der Übergang zwischen den

beiden Stromversorgungen muss manuell erfolgen, indem ein Hebel im oberen Teil des Ofens betätigt wird. Jedes Mal, wenn Sie es einschalten, haben Sie die Wahl.

# BI-FUEL LIBERA

★ PATENT PENDING ★

## Dimensioni della camera di combustione

Dimensions of the combustion chamber

Dimensions de la chambre de combustion

Abmessungen der Verbrennungskammer

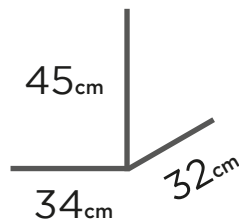

## La stufa con cui sei libero di scegliere

Libera ha un funzionamento manuale: puoi impostare l'accensione automatica con la programmazione oraria di una stufa a pellet, oppure puoi accendere la legna con l'accendifuoco -anche in assenza di corrente elettrica. A ogni cambio di alimentazione la camera di combustione ha

bisogno di raffreddarsi, e di essere impostata manualmente sul nuovo combustibile tramite una leva manuale. Libera rappresenta il sistema per unire due prodotti in uno: sei libero di accenderla come una stufa a legna tradizionale, oppure come una moderna stufa a pellet.

## With Libera, you are free to choose

Libera works with manual operation: you can set a time-programmed automatic ignition as with a normal pellet stove, or you can turn it on, even in the absence of electricity, by lighting the wood with a firelighter. Every time you change the type

of fuel supply, the combustion chamber needs to cool down. You will have to set the new fuel manually via a lever. Libera combines two products in one: you are free to turn it on like a traditional wood stove or like a modern pellet stove.

## Avec Libera, vous êtes libre de choisir

Libera est géré manuellement : vous pouvez programmer un allumage automatique comme avec un poêle à granulés normal, ou vous pouvez l'allumer, même en l'absence d'électricité, en allumant le bois avec un allume-feu. Chaque fois que vous modifiez le type d'alimentation

en carburant, la chambre de combustion doit refroidir. Vous devrez régler le nouveau carburant manuellement via un levier. Libera combine deux produits en un : vous êtes libre de l'allumer comme un poêle à bois traditionnel ou comme un poêle à granulés moderne.

## Der Ofen, mit dem du frei wählst

Libera verfügt über eine manuelle Bedienung: Sie können die automatische Zündung mit der Zeitprogrammierung eines Pelletofens einstellen oder das Holz mit dem Feueranzünder anzünden - auch ohne Strom. Bei jedem Brennstoffwechsel muss die Brennkammer abkühlen

und mittels eines Handhebels manuell auf den neuen Brennstoff eingestellt werden. Libera ist das System, das zwei Produkte in einem vereint: Sie können ihn als traditionellen Holzofen oder als modernen Pelletofen befeuern.



PELLET / GRANULES



LEGNA / WOOD / HOLZ

8

**Accensione automatica del pellet**  
Automatic pellet ignition  
Allumage automatique des granulés  
Automatische Pelletzündung

7

**Passaggio manuale al pellet**  
Manual transition to pellet mode  
Passage manuel au granulés  
Manueller Übergang zum Pelletmodus

6

**Attesa spegnimento legna**  
Wait for the wood to stop burning  
Attendez que le bois arrête de brûler  
Wartung auf Holz-Abschaltung



1

**Funzionamento a pellet**  
Pellet mode  
Mode granulés  
Pelletbetrieb



5

**Funzionamento a legna**  
Wood mode  
Mode bois  
Holzbefeuert

2

**Spegnimento pellet**  
Pellet shutdown  
Arrêt des granulés  
Pellet-Abschaltung

3

**Passaggio manuale alla legna**  
Manual transition to wood mode  
Passage manuel au bois  
Manueller Übergang zum Holzmodus

4

**Accensione manuale legna**  
Manual wood ignition  
Allumage manuel du bois  
Manuelle Holzzündung

POT. 4,6 - 10,3 kW

# LIBERA

★ PATENT PENDING ★

127  
55

## Stufa bifuel pellet e legna, ermetica 5 stelle con alimentazione bifuel.

Libera è la stufa bifuel a doppia alimentazione, con passaggio manuale tra i combustibili. È dotata di braciere autopulente durante l'utilizzo a pellet. Funzionamento a convezione naturale, la ventilazione superiore è completamente escludibile.

## Pellet/wood stove, 5-star, airtight, equipped with dual fuel power supply.

Libera is a dual-fuel stove with a manual fuel-switching system. It is equipped with a self-cleaning brazier (for pellet mode), natural convection, upper ventilation (which can be completely deactivated).

## Poêle à granulés/bois, 5 étoiles, hermétique, équipé d'une alimentation bicomcombustible.

Libera est un poêle bicomcombustible doté d'un système de changement de combustible manuel. Il est équipé d'un brasier autonettoyant (pour le mode granulés), d'une convection naturelle, d'une ventilation supérieure (qui peut être complètement désactivée).

## Dual-Brennstoff-Pellet- und Holzofen, 5-Sterne-Luftdichtheit mit Dual-Brennstoff-Stromversorgung.

Libera ist der Zweistoffofen mit manueller Umschaltung zwischen den Brennstoffen. Es ist mit einer selbstreinigenden Brennschale ausgestattet, wenn es mit Pellets betrieben wird. Natürlicher Konvektionsbetrieb, die obere Belüftung kann vollständig ausgeschlossen werden.



AUTOMATIC  
CLEANING



CLEAN-GLASS  
SYSTEM



HERMETIC  
CONSTRUCTION



HIDDEN  
LOADING



NATURAL  
CONVECTION



PELLET  
OPTIMIZER



NOBIS SAFETY  
STANDARD



ECODESIGN  
2022



Nero  
Black  
Noir  
Schwarz



Bronzo  
Bronze  
Bronze  
Bronze



PELLET

15 kg

WEIGHT

250 kg

ENERGY

A+

D.M. 186

★★★★★

F. VERTE

7★

WI-FI



REMOTE



FREE TO CHOOSE

# HYBRID



Il sistema ibrido: doppia alimentazione pellet e legna con funzionamento automatico.

Our hybrid system: dual fuel (pellet and wood) and automatic operation.

Notre système hybride: bicombustible (granulés et bois) et fonctionnement automatique.

Das Hybridsystem: Duale Pellet- und Holzzuführung mit Automatikbetrieb.



### La stufa ibrida semplicemente **unica**.

## Ibrido, due alimentazioni funzionamento automatico

Il nostro concetto di ibrido è racchiuso nella possibilità che due alimentazioni convivano in simbiosi.

La stufa riconosce in modo automatico pellet e legna, e regola il suo funzionamento e i suoi parametri di conseguenza. Il nostro ibrido si accende e si pulisce da solo, imposta

automaticamente l'aggiunta o la sospensione del pellet, si spegne e si riavvia in autonomia, senza bisogno di intervento umano. Quando desideri puoi aggiungere la legna nella camera di combustione. Sarà la stufa a sapere cosa fare, anche quando le braci si saranno esaurite.

## Hybrid, two power supplies, automatic operation

Our concept of hybrid stove lies in the symbiotic coexistence of two different power supplies. The stove is able to automatically recognize both pellets and wood, and to adjust operation and parameters accordingly. Our hybrid stove turns on and cleans itself,

manages the loading of pellets, turns off, and restarts automatically, without the need for human intervention. You can add wood to the combustion chamber whenever you want. The stove will know what to do, even when the embers have run out.

## Hybride, deux alimentations, fonctionnement automatique

Notre concept de poêle hybride réside dans la coexistence symbiotique de deux alimentations différentes. Le poêle est capable de reconnaître automatiquement les granulés et le bois et d'ajuster le fonctionnement et les paramètres en conséquence. Notre poêle hybride s'allume

et se nettoie tout seul, gère le chargement des granulés, s'éteint et redémarre automatiquement, sans intervention humaine. Vous pouvez ajouter du bois dans la chambre de combustion quand vous le souhaitez. Le poêle saura quoi faire, même lorsque les braises seront épuisées.

## Hybrid, zwei Zuführungen, automatischer Betrieb

Unser Hybridkonzept besteht in der Möglichkeit, dass zwei Zuführungsformen in Symbiose koexistieren. Der Ofen erkennt Pellets und Holz automatisch und regelt seinen Betrieb und seine Parameter entsprechend. Unser Hybrid schaltet sich ein und reinigt sich selbst, stellt automatisch die Pelletzugabe

oder -unterbrechung ein, schaltet sich aus und startet autonom neu, ohne dass ein menschliches Eingreifen erforderlich ist. Wann immer Sie möchten, können Sie der Brennkammer Holz hinzufügen. Der Ofen weiß, was zu tun ist, auch wenn die Glut erschöpft ist.



# HYBRID UNICA

## Dimensioni della camera di combustione

Dimensions of the  
combustion chamber

Dimensions de  
la chambre de  
combustion

Abmessungen der  
Verbrennungskammer

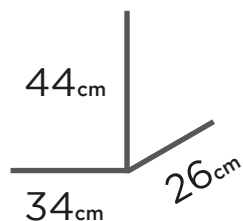

## La stufa autonoma, sa sempre cosa fare

Unica è la nostra stufa ibrida pellet e legna. Grazie alla sua tecnologia il passaggio tra le due alimentazioni viene riconosciuto e gestito autonomamente dalla stufa, che imposta cicli di pulizia automatica, accensioni e spegnimenti in modo indipendente.

Puoi aggiungere un ceppo

durante il funzionamento a pellet, oppure puoi dimenticarti di alimentarla e far esaurire le braci. Unica saprà sempre cosa fare, aggiungerà o sospenderà l'aggiunta di pellet per riscaldare la casa secondo le tue preferenze, senza il tuo intervento.

## The automatic stove always knows what to do

Unica is our hybrid pellet and wood stove. Thanks to its technology, the transition between fuels is completely managed by the stove, which sets cleaning cycles and switches on and off automatically. You can add a log during pellet operation, or you

can just forget to feed it and let the embers run out. Unica will always know what to do, adding or suspending pellet-loading automatically to heat the house according to your preferences with no need for manual intervention.

## Le poêle automatique sait toujours quoi faire

Unica est notre poêle hybride à granulés et à bois. Grâce à sa technologie, la transition entre les combustibles est entièrement gérée par le poêle, qui définit les cycles de nettoyage et s'allume et s'éteint automatiquement. Vous pouvez ajouter une bûche pendant le fonctionnement des

granulés, ou simplement oublier de l'alimenter et laisser les braises s'épuiser. Unica saura toujours quoi faire, en ajoutant ou en suspendant automatiquement le chargement des granulés pour chauffer la maison selon vos préférences, sans intervention manuelle.

## Der autonome Ofen, weiß immer, was zu tun ist

Unser Hybrid-Pellet- und Holzofen ist Unica. Dank seiner Technologie erkennt und verwaltet der Ofen den Übergang von Pellets zu Holz selbstständig, indem Unica automatische Reinigungszyklen einstellt und sich selbstständig ein- und ausschaltet. Sie können während des

Pelletbetriebs einen Scheit nachlegen oder die Beschickung vergessen und die Glut erlöschen lassen. Unica weiß immer, was zu tun ist. Es kann die Zugabe von Pellets hinzufügen oder unterbrechen, um das Haus nach Ihren Wünschen zu heizen, ohne dass Sie eingreifen müssen.



PELLET / GRANULES



LEGNA / WOOD / HOLZ

4

**Pulizia automatica**  
Automatic cleaning  
Nettoyage automatique  
Automatische Reinigung



1

**Funzionamento a pellet**  
Pellet mode  
Mode granulés  
Pelletbetrieb



3

**Funzionamento a legna**  
Wood mode  
Mode bois  
Holzbefeuert



2

**Pulizia automatica**  
Automatic cleaning  
Nettoyage automatique  
Automatische Reinigung

POT. 4,6 - 10,3 kW

10

# UNICA



## Stufa ermetica 5 stelle con alimentazione ibrida pellet e legna.

Convezione naturale, ventilazione superiore completamente escludibile e canalizzazione posteriore con kit opzionale. Braciere autopulente con sistema automatico di controllo della combustione e dell'aria differenziato per combustibile.

## Hermetic, pellet-wood hybrid stove.

Natural convection (it can be deactivated completely), top ventilation and rear canalization (available with optional kit). Self-cleaning brazier with automatic combustion/airflow control system optimized according to the fuel employed.

## Poêle étanche hybride (granulés-bois).

Convection naturelle entièrement désactivable, ventilation supérieure et canalisation arrière (disponible avec kit en option). Brasier autonettoyant avec système de contrôle automatique de la combustion et du débit d'air, optimisé en fonction du combustible utilisé.

## Hermetischer Pellet-Holz-Hybridofen

Natürliche Konvektion (kann vollständig deaktiviert werden), obere Belüftung und hintere Kanalisierung (mit optionalem Kit erhältlich). Selbstreinigende Brennschale mit automatischem Verbrennungs-/Luftstrom-Kontrollsystem, optimiert je nach verwendetem Brennstoff.



AUTOMATIC CLEANING



CLEAN-GLASS SYSTEM



HERMETIC CONSTRUCTION



HIDDEN LOADING



NATURAL CONVECTION



PELLET OPTIMIZER



NOBIS SAFETY STANDARD



ECODESIGN 2022



Carrara



Dark



Grey



Night



White





PELLET

18 kg

WEIGHT

250 kg

ENERGY

A+

D.M. 186

★★★★★

F.VERTE

7★

WI-FI



REMOTE



CANAL.



Single

POT. 4,1 - 8,5 kW | 4,1 - 10,4 kW

A8 | A10

# ROUND ROUND TOP ROUND TOP COAX

ROUND



ROUND TOP



**Stufa a pellet a convezione naturale e ventilazione frontale totalmente escludibile, con canalizzazione posteriore singola con kit opzionale.**

Design moderno, porta con doppio vetro, laterale in acciaio verniciato e finitura in ceramica sui pannelli inferiori, top in ghisa. Pulizia automatica del braciere, sistema di caricamento pellet nascosto, motoriduttore brushless con tecnologia Silent.

**Poêle à granulés à convection naturelle équipé d'une ventilation frontale (entièrement désactivable) et canalisation arrière unique (kit en option).**

Design moderne, porte à double vitrage, panneaux latéraux en acier verni et panneau inférieur avec finition en céramique. Couvercle supérieure en fonte. Brasier autonettoyant, système de chargement des pellets caché, motoréducteur sans balais (technologie Silent).

**Natural-convection pellet stove equipped with front ventilation (which can be deactivated completely) and single rear canalization (optional kit).**

Modern design, double-glass door, painted-steel side panels and bottom panel with ceramic finish. Cast-iron top cover. Self-cleaning brazier, hidden pellet-loading system, brushless gearmotor (Silent technology).

**Pelletofen mit natürlicher Konvektion, mit vorderer Belüftung (die vollständig deaktiviert werden kann) und einzelner hinterer Kanalisierung (optionaler Bausatz) ausgestattet.**

Modernes Design, Doppelglastür, Seitenwände und Bodenplatte aus lackiertem Stahl mit Keramikoberfläche. Obere Abdeckung aus Gusseisen. Selbstreinigende Brennschale, verstecktes Pelletladesystem, bürstenloser Getriebemotor (Silent Technology).



AUTOMATIC CLEANING



CLEAN-GLASS SYSTEM



HERMETIC CONSTRUCTION



HIDDEN LOADING



NATURAL CONVECTION



PELLET OPTIMIZER



NOBIS SAFETY STANDARD



ECODESIGN 2022



Bianco  
White  
Blanc  
Weiß



Nero  
Black  
Noir  
Schwarz



Bordeaux  
Bordeaux  
Bordeaux  
Bordeaux



Nocciola  
Hazelnut  
Noisette  
Haselnuss





PELLET

19 kg  
TOP 15 kg

WEIGHT

175 kg

ENERGY

A++

D.M. 186

★★★★★

F.VERTE

7★

WI-FI



REMOTE



CANAL.



Single

POT. 4,1 - 8,5 kW | 4,1 - 10,4 kW



**Finitura ceramica bianca con uscita fumi posteriore Ø80cm**

White ceramic finish with Ø80cm rear flue exit pipe  
Finition en céramique blanche avec sortie de fumées arrière de Ø80cm  
Weiße Keramikoberfläche mit Ø80 cm hinterem Rauchabzugsrohr



**Uscita fumi superiore disponibile anche in versione coassiale**

Upper flue exit pipe also available in Co-axial version  
Conduit de fumée supérieur disponible en version Co-axiale  
Oberes Rauchabzugsrohr auch in koaxialer Ausführung erhältlich

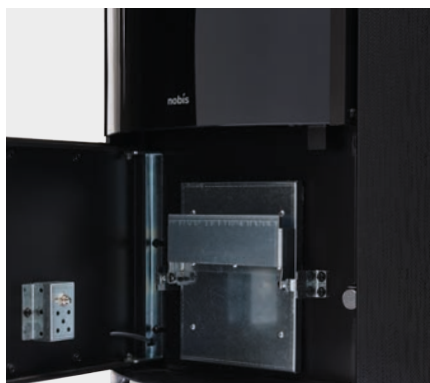

**Cassetto cenere estraibile**

Removable ash drawer  
Tiroir à cendres amovible  
Herausnehmbare Ascheschublade





PELLET

19 kg  
TOP 15 kg

WEIGHT

175 kg

ENERGY

A++

D.M. 186

★★★★★

F.VERTE

7★

WI-FI



REMOTE



CANAL.



Single



A8 | A10

# ROUND GLASS ROUND TOP GLASS ROUND TOP GLASS COAX

ROUND



ROUND TOP



**Stufa a pellet a convezione naturale e ventilazione frontale totalmente escludibile, canalizzazione posteriore con kit opzionale e finitura in vetro.**

Design moderno, laterali in vetro con finitura effetto carbonio, wengé, silver e nero. Porta con doppio vetro, pulizia automatica del braciere e sistema di caricamento pellet nascosto. Motoriduttore brushless con tecnologia Silent, Wi-Fi di serie e palmare con funzione termostato ambiente.

**Poêle à granulés à convection naturelle équipé d'une ventilation frontale (entièrement désactivable), canalisation arrière (kit en option) et finition en verre.**

Design moderne, panneaux latéraux en verre disponibles en Finition effet carbone, wengé, argent ou noir. Porte à double vitrage, brasier autonettoyant, système de chargement des pellets caché. Motoréducteur sans balais (technologie Silent), WiFi (fourni en standard) et télécommande équipée d'une fonction thermostat.

**Natural-convection pellet stove equipped with front ventilation (which can be deactivated completely), rear canalization (optional kit) and glass finish.**

Modern design, glass side panels available in carbon-fiber/wengé/silver effect or black. Double-glass door, self-cleaning brazier, hidden pellet-loading system. Brushless gearmotor (Silent technology), WiFi (supplied as standard) and remote control equipped with thermostat function.

**Pelletofen mit natürlicher Konvektion, mit vorderer Belüftung (die vollständig deaktiviert werden kann), hinterer Kanalisierung (optionaler Bausatz) und Glasoberfläche ausgestattet.**

Modernes Design, Glasseitenwände in den Farben Kohlefaser/Wenge/Silbereffekt oder Schwarz erhältlich. Doppelglastür, selbstreinigende Brennschale, verstecktes Pelletladesystem. Bürstenloser Getriebemotor (Silent Technology), WiFi (im Lieferumfang enthalten) und Fernbedienung Steuerung mit Thermostatfunktion.



### Carbon look

Carbon look  
Finition effet carbone  
Carbon look



### Finitura Silver

Silver finish  
Finition couleur argent  
Silberfarbene Oberfläche



### Black Glass

Black Glass finish  
Finition en verre noir  
Schwarze Glasoberfläche



### Finitura Wengé Noir

Wenge Noir finishing  
Finition en wengé noir  
Wenge-Noir-Oberfläche



AUTOMATIC  
CLEANING



CLEAN-GLASS  
SYSTEM



HERMETIC  
CONSTRUCTION



HIDDEN  
LOADING



NATURAL  
CONVECTION



PELLET  
OPTIMIZER



NOBIS SAFETY  
STANDARD



ECODESIGN  
2022



PELLET

19 kg  
TOP 15 kg

WEIGHT

175 kg

ENERGY

A++

D.M. 186

★★★★★

F.VERTE

7★

WI-FI



REMOTE



CANAL.



Single

POT. 4,1 - 8,5 kW | 4,1 - 10,4 kW



#### **Finitura glass silver**

Silver-glass finish  
Finition couleur argent  
Silberglasoberfläche



#### **Uscita fumi superiore disponibile anche in versione coassiale**

Upper flue exit pipe also available in co-axial version  
Conduit de fumée supérieur disponible en version co-axiale  
Koaxiale Version



#### **Cassetto cenere estraibile**

Removable ash drawer  
Tiroir à cendres amovible  
Herausnehmbare Ascheschublade

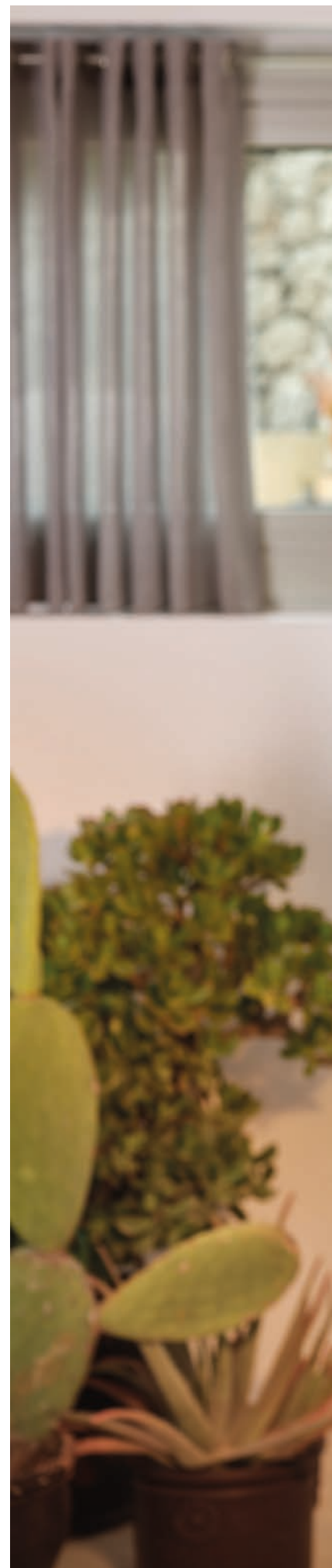



PELLET

19 kg  
TOP 15 kg

WEIGHT

175 kg

ENERGY

A++

D.M. 186

★★★★★

F.VERTE

7★

WI-FI



REMOTE



CANAL.



Single

A8 | A10

# ROUND STEEL ROUND TOP STEEL ROUND TOP COAX STEEL

ROUND



ROUND TOP



**Stufa a pellet a convezione naturale e ventilazione frontale totalmente escludibile, con canalizzazione posteriore singola con kit opzionale.**

Design moderno, porta in acciaio, laterale in acciaio verniciato, top in ghisa. Pulizia automatica del braciere, sistema di caricamento pellet nascosto, motoriduttore brushless con tecnologia Silent. Wifi opzionale e display a bordo macchina.

**Poêle à granulés à convection naturelle équipé d'une ventilation frontale (entièrement désactivable) et canalisation arrière unique (kit en option).**

Design moderne, porte en acier, côtés en acier peint, dessus en fonte. Nettoyage automatique du braseiro, système de chargement des pellets caché, moteur sans balais avec technologie Silent. Wifi en option et écran à bord.

**Natural-convection pellet stove equipped with front ventilation (which can be deactivated completely) and single rear canalization (optional kit).**

Modern design, steel door, painted steel side, cast iron top. Automatic brazier cleaning, hidden pellet loading system, brushless gear motor with Silent technology. Optional Wifi and display on board machine.

**Pelletofen mit natürlicher Konvektion, ausgestattet mit Frontlüftung (die vollständig deaktiviert werden kann) und einfacher hinterer Kanalisierung (optionaler Bausatz).**

Modernes Design, Stahltür, lackierte Stahlseiten, Gusseisenplatte. Automatische Reinigung der Feuerstelle, verstecktes Pellet-Ladesystem, bürstenloser Getriebemotor mit Silent-Technologie. Optional Wifi und On-Board-Display.



AUTOMATIC CLEANING



CLEAN-GLASS SYSTEM



HERMETIC CONSTRUCTION



HIDDEN LOADING



NATURAL CONVECTION



PELLET OPTIMIZER



NOBIS SAFETY STANDARD



ECODESIGN 2022



Bianco  
White  
Blanc  
Weiß



Nero  
Black  
Noir  
Schwarz



Bronzo  
Bronze  
Bronze  
Bronze

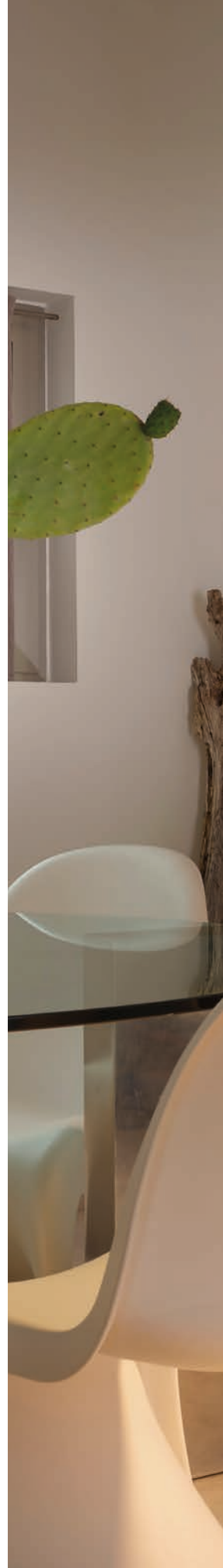



PELLET

19 kg  
TOP 15 kg

WEIGHT

175 kg

ENERGY

A++

D.M. 186

★★★★★

F.VERTE

7★

WI-FI

Optional

REMOTE

Optional

CANAL.



Single

POT. 4,9 - 9,9 kW

B10 V

# ULISSE CLASSIC



## Stufa a pellet con ventilazione frontale e scarico posteriore

Stufa a pellet di dimensioni compatte con piedini di supporto. Comando della stufa tramite palmare con funzione di termostato ambiente o con Wi-Fi tramite kit optional. Motoriduttore brushless, porta in vetro e rivestimento in acciaio verniciato.

## Poêle à granulés avec ventilation frontale et échappement arrière

Poêle à granulés compact avec pieds de support. Le poêle peut être géré via une télécommande équipée de la fonction thermostat d'ambiance ou avec Wi-Fi (via kit en option). Motoréducteur sans balais, porte vitrée et revêtement en acier peint.

## Pellet stove with front ventilation and rear exhaust

Compact pellet stove with support feet. The stove can be managed via a remote control equipped with room thermostat function or with Wi-Fi (via optional kit). Brushless gearmotor, glass door and painted steel cladding.

## Pelletofen mit vorderer Belüftung und hinterer Abluft

Pelletofen mit vorderer Belüftung und hinterer Abluft  
Kompakter Pelletofen mit Stützfüßen.  
Steuerung des Ofens über Fernbedienung mit Raumthermostatfunktion oder über Wi-Fi über optionales Kit. Bürstenloser Getriebemotor, Glastür und lackierte Stahlverkleidung.



CLEAN-GLASS SYSTEM



PELLET OPTIMIZER



NOBIS SAFETY STANDARD



ECODESIGN 2022





PELLET

12 kg

WEIGHT

95 kg

ENERGY

A+

D.M. 186

★★★★★

F.VERTE

7★

WI-FI

Optional

REMOTE

✓



POT. 4,1 - 9,5 kW

A9

# ZENITH



AUTOMATIC  
CLEANING



CLEAN-GLASS  
SYSTEM



HERMETIC  
CONSTRUCTION



HIDDEN  
LOADING



NATURAL  
CONVECTION



PELLET  
OPTIMIZER



NOBIS SAFETY  
STANDARD



ECODESIGN  
2022

**Stufa a pellet ermetica con scarico posteriore a convezione naturale, ventilazione frontale escludibile e canalizzazione posteriore opzionale fino a 8 mt.**

Rivestimento in acciaio verniciato e porta in vetro. È dotata di sistema automatico di controllo della combustione e braciere autopulente, comando della stufa con palmare e wi-fi di serie e motoriduttore brushless con tecnologia Silent.

**Poêle à granulés hermétique avec conduit de fumée arrière, convection naturelle, ventilation frontale désactivable et conduit arrière optionnel jusqu'à 8 mètres.**

Bardage en acier peint et porte en verre. Équipé d'un système de contrôle automatique de la combustion, d'un brasier autonettoyant, d'une télécommande et connexion Wi-Fi (fournis en standard) et d'un motoréducteur sans balais équipé de la technologie Silent.

**Hermetic pellet stove with rear exhaust pipe, natural convection, front ventilation (which can be deactivated) and optional rear canalization up to 8 meters.**

Painted steel cladding and glass door. Equipped with automatic combustion-control system and self-cleaning brazier, remote control and Wi-Fi connection (supplied as standard), brushless gearmotor equipped with Silent technology.

**Hermetischer Pelletofen mit hinterem Abgasrohr, natürlicher Konvektion, vorderer Belüftung (deaktivierbar) und optionaler hinterer Kanalisierung bis zu 8 Metern.**

Verkleidung aus lackiertem Stahl und Glastür. Ausgestattet mit automatischem Verbrennungskontrollsystem und selbstreinigender Brennschale, Fernbedienung und WiFi-Verbindung (im Lieferumfang enthalten), bürstenlosem Getriebemotor mit Silent Technology.



Bianco  
White  
Blanc  
Weiß



Nero  
Black  
Noir  
Schwarz



Bordeaux  
Bordeaux  
Bordeaux  
Bordeaux



Bronzo  
Bronze  
Bronze  
Bronze





PELLET

19 kg

WEIGHT

163 kg

ENERGY

A++

D.M. 186

★★★★★

F.VERTE

7★

WI-FI



REMOTE



CANAL.



Single

POT. 4,1 - 10,4 kW

A10

# ZENITH PLUS



AUTOMATIC CLEANING



CLEAN-GLASS SYSTEM



HERMETIC CONSTRUCTION



HIDDEN LOADING



NATURAL CONVECTION



PELLET OPTIMIZER



NOBIS SAFETY STANDARD



ECODESIGN 2022

**Stufa a pellet ermetica con scarico posteriore a convezione naturale, ventilazione frontale escludibile e canalizzazione posteriore opzionale fino a 8 mt.**

Rivestimento in acciaio verniciato e porta in vetro. È dotata di sistema automatico di controllo della combustione e braciere autopulente, comando della stufa con palmare e Wi-Fi di serie e motoriduttore brushless con tecnologia Silent.

**Hermetic pellet stove with rear exhaust pipe, natural convection, front ventilation (which can be deactivated completely) and optional rear canalization up to 8 meters.**

Painted steel cladding and glass door. Equipped with automatic combustion-control system and self-cleaning brazier, remote control and Wi-Fi connection (supplied as standard), brushless gearmotor equipped with Silent technology.

**Poêle à granulés hermétique avec conduit de fumée arrière, convection naturelle, ventilation frontale désactivable et conduit arrière optionnel jusqu'à 8 mètres.**

Bardage en acier peint et porte en verre. Équipé d'un système de contrôle automatique de la combustion, d'un brasier autonettoyant, d'une télécommande et connexion Wi-Fi (fournis en standard) et d'un motoréducteur sans balais équipé de la technologie Silent.

**Hermetischer Pelletofen mit hinterem Abgasrohr, natürlicher Konvektion, vorderer Belüftung (die vollständig deaktiviert werden kann) und optionaler hinterer Kanalisierung bis zu 8 Metern.**

Verkleidung aus lackiertem Stahl und Glastür. Ausgestattet mit automatischem Verbrennungskontrollsystem und selbstreinigender Brennschale, Fernbedienung und WiFi-Verbindung (im Lieferumfang enthalten), bürstenlosem Getriebemotor mit Silent Technology.



Bianco  
White  
Blanc  
Weiß



Nero  
Black  
Noir  
Schwarz



Bordeaux  
Bordeaux  
Bordeaux  
Bordeaux



Bronzo  
Bronze  
Bronze  
Bronze



PELLET

19 kg

WEIGHT

163 kg

ENERGY

A++

D.M. 186

★★★★★

F.VERTE

7★

WI-FI



REMOTE



CANAL.



Single

POT. 4,1 - 8,5 kW

A8

# QUADRA QUADRA TOP

QUADRA

QUADRA TOP



AUTOMATIC  
CLEANING



CLEAN-GLASS  
SYSTEM



HERMETIC  
CONSTRUCTION



HIDDEN  
LOADING



NATURAL  
CONVECTION



PELLET  
OPTIMIZER



NOBIS SAFETY  
STANDARD



ECODESIGN  
2022

**Stufa a pellet a convezione naturale e ventilazione frontale totalmente escludibile, con canalizzazione singola con kit opzionale.**

Quadra è una stufa a pellet ermetica a convezione naturale e ventilazione frontale. Canalizzazione posteriore fino a 8 metri con kit dedicato. Braciere autopulente e tecnologia Silent, wi-fi di serie e palmare con funzione di termostato ambiente.

**Poêle à granulés à convection naturelle équipé d'une ventilation frontale (qentièrément désactivable) et d'un kit de canalisation simple (en option).**

Quadra est un poêle à granulés hermétique à convection naturelle et ventilation frontale. Canalisation arrière jusqu'à 8 mètres avec kit dédié. Équipé d'un brasier autonettoyant et de la technologie Silent, le poêle peut être géré via une télécommande avec fonction thermostat d'ambiance.

**Natural-convection pellet stove equipped with front ventilation (which can be deactivated completely) and single canalization kit (optional).**

Quadra is a hermetic pellet stove with natural convection and front ventilation. Rear canalization up to 8 meters with dedicated kit. Equipped with self-cleaning brazier and Silent technology, the stove can be managed via remote control with room thermostat function.

**Pelletofen mit natürlicher Konvektion, mit Frontlüftung (die vollständig deaktiviert werden kann) und Einzelkanalisierungssatz (optional) ausgestattet.**

Quadra ist ein hermetischer Pelletofen mit natürlicher Konvektion und Frontbelüftung. Hintere Kanalisierung bis zu 8 Meter mit speziellem Kit. Ausgestattet mit selbstreinigender Brennschale und Silent Technology kann der Ofen über eine Fernbedienung mit Raumthermostatfunktion gesteuert werden.



Bianco  
White  
Blanc  
Weiß



Nero  
Black  
Noir  
Schwarz



Bordeaux  
Bordeaux  
Bordeaux  
Bordeaux



Bronzo  
Bronze  
Bronze  
Bronze



PELLET

19 kg  
TOP 15 kg

WEIGHT

153 kg

ENERGY

A++

D.M. 186

★★★★★

F.VERTE

7★

WI-FI



REMOTE



CANAL.



Single

POT. 4,1 - 10,4 kW

A10

# QUADRA PLUS QUADRA PLUS TOP

QUADRA PLUS

QUADRA PLUS TOP

112  
44 | 50

112  
44 | 56



AUTOMATIC  
CLEANING



CLEAN-GLASS  
SYSTEM



HERMETIC  
CONSTRUCTION



HIDDEN  
LOADING



NATURAL  
CONVECTION



OPTIMIZE  
COMBUSTION



NOBIS SAFETY  
STANDARD



ECODESIGN  
2022

**Stufa a pellet ermetica con scarico posteriore o superiore, a convezione naturale, ventilazione frontale escludibile e canalizzazione posteriore destra opzionale**

Finiture in gres effetto pietra e marmo, stile minimal, braciere autopulente e tecnologia Perfect per ottimizzazione consumi e rendimento. Motoriduttore brushless con tecnologia Silent, wifi integrato e palmare.

**Hermetic pellet stove with rear or top exhaust pipe, natural convection, front ventilation (which can be deactivated) and optional rear right canalization.**

Stoneware and marble effect finishes, minimalist style, self-cleaning brazier and Perfect technology to optimise consumption and efficiency. Brushless gearmotor equipped with Silent technology, remote control and integrated WiFi.

**Poêle à granulés hermétique avec échappement arrière ou supérieure, convection naturelle, ventilation avant (désactivable) et canalisation arrière droite en option.**

Finitions effet grès et marbre, style minimaliste, brasier autonettoyant et technologie Perfect pour optimiser la consommation et l'efficacité. Motoréducteur sans balais équipé de la technologie Silent, WiFi intégré et télécommande.

**Hermetischer Pelletofen mit Abgasrohr hinten oder oben, natürlicher Konvektion, Belüftung vorne (deaktivierbar) und optionaler Kanalisierung hinten rechts.**

Oberflächen in Steinzeug- und Marmoroptik, minimalistischer Stil, selbstbeheizende Feuerschale und perfekte Technologie zur Optimierung von Verbrauch und Effizienz. Bürstenloser Getriebemotor mit Silent Technology, Fernbedienung und integriertem WiFi.



Dark



Black glass



Night



White



Grey



Carrara



Silver



Carbon look



Wengé noir



PELLET

19 kg  
TOP 15 kg

WEIGHT

153 kg

ENERGY

A++

D.M. 186

★★★★★

F.VERTE

7★

WI-FI



REMOTE



CANAL.



Single



POT. 4,1 - 9,5 kW

A9

# CLASSIC

118  
53



AUTOMATIC  
CLEANING



CLEAN-GLASS  
SYSTEM



HERMETIC  
CONSTRUCTION



HIDDEN  
LOADING



NATURAL  
CONVECTION



PELLET  
OPTIMIZER



NOBIS SAFETY  
STANDARD



ECODESIGN  
2022

**Stufa a pellet ermetica con scarico posteriore, a convezione naturale, ventilazione superiore escludibile e canalizzazione posteriore opzionale fino a 8 metri.**

Classic è una stufa con rivestimento in maiolica colorata che richiama le forme della tradizione. È dotata di sistema automatico di controllo della combustione e braciere autopulente, comando della stufa con palmare e Wi-Fi di serie e motoriduttore brushless con tecnologia Silent.

**Poêle à granulés étanche équipé avec système d'évacuation arrière, convection naturelle, ventilation supérieure (entièrement désactivable) et canalisation arrière optionnelle jusqu'à 8 mètres.**

Classic est un poêle avec un revêtement en majolique colorée rappelant les formes traditionnelles. Il est équipé d'un système de contrôle automatique de la combustion, d'un brasier autonettoyant et d'un motoréducteur sans balais avec technologie Silent. Le poêle peut être contrôlé par télécommande et le Wi-Fi est fourni en standard.

**Hermetic pellet stove with rear exhaust pipe, natural convection, upper ventilation (which can be deactivated completely) and optional rear canalization up to 8 meters.**

Classic is a stove with colored majolica cladding recalling traditional shapes. It is equipped with automatic combustion-control system, self-cleaning brazier and brushless gear motor with Silent technology. The stove can be managed via remote control and Wi-Fi is supplied as standard.

**Hermetischer Pelletofen mit hinterem Abgasrohr, natürlicher Konvektion, oberer Belüftung (die vollständig deaktiviert werden kann) und optionaler hinterer Kanalisierung bis zu 8 Metern.**

Classic ist ein Ofen mit farbiger Majolika-Verkleidung, die an traditionelle Formen erinnert. Er ist mit einem automatischen Verbrennungskontrollsystem, einer selbstreinigenden Brennschale und einem bürstenlosen Getriebemotor mit Silent-Technologie ausgestattet. Der Ofen kann per Fernbedienung gesteuert werden und WiFi ist standardmäßig im Lieferumfang enthalten.



Bianco  
White  
Blanc  
Weiß



Nero  
Black  
Noir  
Schwarz



Bordeaux  
Bordeaux  
Bordeaux  
Bordeaux



Nocciola  
Hazelnut  
Noisette  
Haselnuss

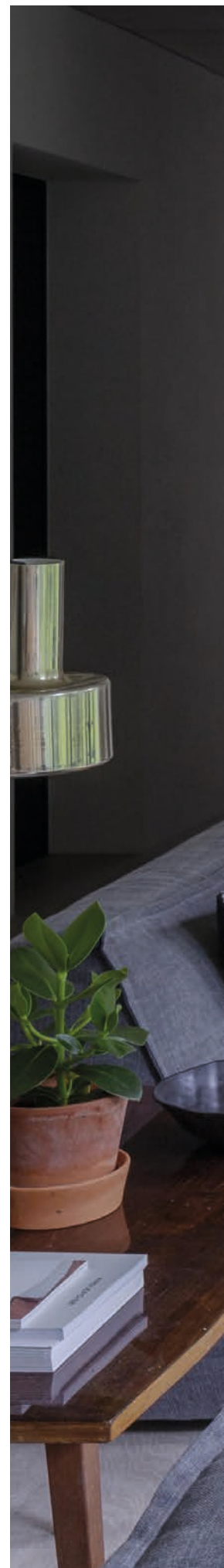



PELLET

19 kg

WEIGHT

185 kg

ENERGY

A++

D.M. 186

★★★★★

F.VERTE

7★

WI-FI



REMOTE



CANAL.



Single

## A10

# CLASSIC PLUS



118  
53



AUTOMATIC  
CLEANING



CLEAN-GLASS  
SYSTEM



HERMETIC  
CONSTRUCTION



HIDDEN  
LOADING



NATURAL  
CONVECTION



PELLET  
OPTIMIZER



NOBIS SAFETY  
STANDARD



ECODESIGN  
2022

**Stufa a pellet ermetica con scarico posteriore, a convezione naturale, ventilazione frontale escludibile e canalizzazione posteriore opzionale fino a 8 metri**

Classic è una stufa con rivestimento in maiolica colorata che richiama le forme della tradizione. È dotata di sistema automatico di controllo della combustione e braciere autopulente, comando della stufa con palmare e Wi-Fi di serie e motoriduttore brushless con tecnologia Silent

**Poêle à granulés étanche équipé avec système d'évacuation arrière, convection naturelle, ventilation frontale (entièrement désactivable) et canalisation arrière optionnelle jusqu'à 8 mètres.**

Classic est un poêle avec un revêtement en majolique colorée rappelant les formes traditionnelles. Il est équipé d'un système de contrôle automatique de la combustion, d'un brasier autonettoyant et d'un motoréducteur sans balais avec technologie Silent. Le poêle peut être contrôlé par télécommande et le Wi-Fi est fourni en standard.

**Hermetic pellet stove with rear exhaust pipe, natural convection, front ventilation (which can be deactivated completely) and optional rear canalization up to 8 meters.**

Classic is a stove with colored majolica cladding recalling traditional shapes. It is equipped with automatic combustion-control system, self-cleaning brazier and brushless gear motor with Silent technology. The stove can be managed via remote control and Wi-Fi is supplied as standard.

**Hermetischer Pelletofen mit hinterem Abgasrohr, natürlicher Konvektion, vorderer Belüftung (die vollständig deaktiviert werden kann) und optionaler hinterer Kanalisierung bis zu 8 Metern.**

Classic ist ein Ofen mit farbiger Majolika-Verkleidung, die an traditionelle Formen erinnert. Er ist mit einem automatischen Verbrennungskontrollsystem, einer selbstreinigenden Brennschale und einem bürstenlosen Getriebemotor mit Silent-Technologie ausgestattet. Der Ofen kann per Fernbedienung gesteuert werden und WiFi ist standardmäßig im Lieferumfang enthalten .



Bianco  
White  
Blanc  
Weiß



Nero  
Black  
Noir  
Schwarz



Bordeaux  
Bordeaux  
Bordeaux  
Bordeaux



Nocciola  
Hazelnut  
Noisette  
Haselnuss





PELLET

19 kg

WEIGHT

185 kg

ENERGY

A++

D.M. 186

★★★★★

F.VERTE

7★

WI-FI



REMOTE



CANAL.



Single

POT. 4,1 - 8,5 kW | 4,1 - 10,4 kW

## A8 | A10

# STYLE

112  
56  
50



AUTOMATIC  
CLEANING



CLEAN-GLASS  
SYSTEM



HERMETIC  
CONSTRUCTION



HIDDEN  
LOADING



NATURAL  
CONVECTION



PELLET  
OPTIMIZER



NOBIS SAFETY  
STANDARD



ECODESIGN  
2022

**Stufa a pellet ermetica con scarico posteriore o superiore, a convezione naturale, ventilazione frontale escludibile e canalizzazione posteriore opzionale fino a 8 mt.**

Style è una stufa dal carattere moderno, con finiture in vetro e in componenti lamellari colore rame in metallo. Sistema automatico di controllo della combustione con braciere autopulente, comando della stufa con palmare e Wi-Fi di serie.

**Hermetic pellet stove with rear or top exhaust pipe, natural convection, front ventilation (which can be deactivated completely) and optional rear canalization up to 8 meters.**

Style is a modern stove with glass and copper-coloured metal finishes. It is equipped with automatic combustion-control system and self-cleaning brazier. It can be managed via remote control and WiFi is supplied as standard.

**Poêle à granulés étanche avec tuyau d'évacuation arrière ou supérieur, convection naturelle, ventilation avant (entièrement désactivable) et canalisation arrière optionnelle jusqu'à 8 mètres.**

Style est un poêle moderne avec des finitions en verre et métal couleur cuivre. Il est équipé d'un système de contrôle automatique de la combustion et d'un brasier autonettoyant. Le poêle peut être contrôlé par télécommande et le WiFi est fourni en standard.

**Hermetischer Pelletofen mit Abgasrohr hinten oder oben, natürlicher Konvektion, Frontbelüftung (die vollständig deaktiviert werden kann) und optionaler Kanalisierung hinten bis zu 8 Metern.**

Style ist ein moderner Ofen mit Glas- und kupferfarbenen Metalloberflächen. Er ist mit einem automatischen Verbrennungskontrollsystem und einer selbstreinigenden Brennschale ausgestattet. Er kann per Fernbedienung gesteuert werden und WiFi ist standardmäßig im Lieferumfang enthalten.





PELLET

19 kg

WEIGHT

180 kg

ENERGY

A++

D.M. 186

★★★★★

F.VERTE

7★

WI-FI



REMOTE



CANAL.



Single

nobis

## A10

# LIGHT

112  
76



AUTOMATIC  
CLEANING



CLEAN-GLASS  
SYSTEM



HERMETIC  
CONSTRUCTION



HIDDEN  
LOADING



NATURAL  
CONVECTION



PELLET  
OPTIMIZER



NOBIS SAFETY  
STANDARD



ECODESIGN  
2022

**Stufa a pellet ermetica con scarico posteriore, convezione naturale, ventilazione frontale e due canalizzazioni di serie fino a 8 metri**

È disponibile con rivestimenti in gres effetto pietra e marmo. È dotata di sistema automatico di controllo della combustione e braciere autopulente, comando della stufa con palmare e Wi-Fi di serie e motoriduttore brushless con tecnologia Silent.

**Poêle à granulés étanche avec tuyau d'évacuation arrière, convection naturelle, ventilation frontale et deux conduits de canalisation standard jusqu'à 8 mètres.**

Il est disponible avec un revêtement en grès effet pierre et marbre. Il est équipé d'un système de contrôle automatique de la combustion, brasier autonettoyant et motoréducteur sans balais avec technologie Silent. Le poêle peut être contrôlé par télécommande et le Wi-Fi est fourni en standard.

**Hermetic pellet stove with rear exhaust pipe, natural convection, front ventilation and two standard canalization ducts up to 8 meters.**

It is available with stone- and marble-effect stoneware cladding. It is equipped with automatic combustion-control system, self-cleaning brazier and brushless gear motor with Silent technology. The stove can be managed via remote control and Wi-Fi is supplied as standard.

**Hermetischer Pelletofen mit hinterem Abgasrohr, natürlicher Konvektion, vorderer Belüftung und zwei Standardkanalisierungskanälen bis zu 8 Metern.**

Er ist mit einer Steinzeugverkleidung in Stein- und Marmoroptik erhältlich. Er ist mit einem automatischen Verbrennungskontrollsystem, einer selbstreinigenden Brennschale und einem bürstenlosen Getriebemotor mit Silent Technology ausgestattet. Der Ofen kann per Fernbedienung gesteuert werden und WiFi ist standardmäßig im Lieferumfang enthalten.



Dark



Black glass



Grey



Night



White



Carrara





PELLET

35 kg

WEIGHT

210 kg

ENERGY

A++

D.M. 186

★★★★★

F.VERTE

7★

WI-FI



REMOTE



CANAL.



Double



POT. 4,1 - 10,4 kW



**Uscita fumi superiore o laterale opzionale.**

Available with upper or side exhaust outlet.  
Disponible avec sortie de fumées supérieure ou latérale.  
Erhältlich mit oberem oder seitlichem Abluftauslass.

**Ampio cassetto cenere rimovibile**

Large removable ash tray.  
Grand tiroir à cendres amovible.  
Großer herausnehmbarer Aschenbecher.



**Doppia canalizzazione Ø60cm laterale, superiore e posteriore**

Double Ø60cm canalization as standard (side, top and rear).  
Canalisation double de Ø60cm en standard; (latéral, supérieure et arrière).  
Standardmäßig doppelte Kanalisierung Ø60 cm (seitlich, oben und hinten).



**Griglia superiore per convezione naturale con ventilazione totalmente escludibile**

Upper grille for natural convection with ventilation (it can be deactivated completely)  
Grille supérieure pour convection naturelle avec ventilation entièrement excluable  
Oberes Gitter für natürliche Konvektion mit Belüftung (komplett deaktivierbar)



PELLET

35 kg

WEIGHT

210 kg

ENERGY

A++

D.M. 186

★★★★★

F.VERTE

7★

WI-FI



REMOTE



CANAL.



Double

POT. 4,1 - 10,4 kW

A10

## LIGHT STYLE

112  
76



AUTOMATIC  
CLEANING



CLEAN-GLASS  
SYSTEM



HERMETIC  
CONSTRUCTION



HIDDEN  
LOADING



NATURAL  
CONVECTION



PELLET  
OPTIMIZER



NOBIS SAFETY  
STANDARD



ECODESIGN  
2022

**Stufa a pellet ermetica con scarico posteriore, convezione naturale, ventilazione frontale e due canalizzazioni di serie fino a 8 metri**

È dotata di sistema automatico di controllo della combustione e bracieri autopulente, comando della stufa con palmare e Wi-Fi di serie e motoriduttore brushless con tecnologia Silent.

**Poêle à granulés étanche avec tuyau d'évacuation arrière, convection naturelle, ventilation frontale et deux conduits de canalisation standard jusqu'à 8 mètres.**

Il est équipé d'un système de contrôle automatique de la combustion, brasier autonettoyant et motoréducteur sans balais avec technologie Silent. Le poêle peut être contrôlé par télécommande et le Wi-Fi est fourni en standard.

**Hermetic pellet stove with rear exhaust pipe, natural convection, front ventilation and two standard canalization ducts up to 8 meters.**

It is equipped with automatic combustion-control system, self-cleaning brazier and brushless gear motor with Silent technology. The stove can be managed via remote control and Wi-Fi is supplied as standard.

**Hermetischer Pelletofen mit hinterem Abgasrohr, natürlicher Konvektion, vorderer Belüftung und zwei Standardkanalisierungskanälen bis zu 8 Metern.**

Er ist mit einem automatischen Verbrennungskontrollsystem, einer selbstreinigenden Brennschale und einem bürstenlosen Getriebemotor mit Silent Technology ausgestattet. Der Ofen kann per Fernbedienung gesteuert werden und WiFi ist standardmäßig im Lieferumfang enthalten.



Legno  
Wood  
Bois  
Wood



Bianco  
White  
Blanc  
Weiß



Nero  
Black  
Noir  
Schwarz





PELLET

35 kg

WEIGHT

210 kg

ENERGY

A++

D.M. 186

★★★★★

F.VERTE

7★

WI-FI



REMOTE



CANAL.



Double

POT. 4,1 - 10,4 kW

A10

# LIGHT 2020

112  
76



AUTOMATIC  
CLEANING



CLEAN-GLASS  
SYSTEM



HERMETIC  
CONSTRUCTION



HIDDEN  
LOADING



NATURAL  
CONVECTION



PELLET  
OPTIMIZER



NOBIS SAFETY  
STANDARD



ECODESIGN  
2022

**Stufa a pellet ermetica con scarico posteriore, convezione naturale, ventilazione frontale e due canalizzazione di serie fino a 8 metri.**

È disponibile con rivestimenti in gres effetto pietra e marmo. È dotata di sistema automatico di controllo della combustione e braciere autopulente, comando della stufa con palmare e Wi-Fi di serie e motoriduttore brushless con tecnologia Silent.

**Poêle à granulés étanche avec tuyau d'évacuation arrière, convection naturelle, ventilation frontale et deux conduits de canalisation standard jusqu'à 8 mètres.**

Il est disponible avec un revêtement en grès effet pierre et marbre. Il est équipé d'un système de contrôle automatique de la combustion, brasier autonettoyant et motoréducteur sans balais avec technologie Silent. Le poêle peut être contrôlé par télécommande et le Wi-Fi est fourni en standard.

**Hermetic pellet stove with rear exhaust pipe, natural convection, front ventilation and two standard canalization ducts up to 8 meters.**

It is available with stone- and marble-effect stoneware cladding. It is equipped with automatic combustion-control system, self-cleaning brazier and brushless gear motor with Silent technology. The stove can be managed via remote control and Wi-Fi is supplied as standard.

**Hermetischer Pelletofen mit hinterem Abgasrohr, natürlicher Konvektion, vorderer Belüftung und zwei Standardkanalisierungskanälen bis zu 8 Metern.**

Er ist mit einer Steinzeugverkleidung in Stein- und Marmoroptik erhältlich. Er ist mit einem automatischen Verbrennungskontrollsystem, einer selbstreinigenden Brennschale und einem bürstenlosen Getriebemotor mit Silent Technology ausgestattet. Der Ofen kann per Fernbedienung gesteuert werden und WiFi ist standardmäßig im Lieferumfang enthalten.



Dark



Night



Grey



Carrara



White



PELLET

35 kg

WEIGHT

210 kg

ENERGY

A++

D.M. 186

★★★★★

F.VERTE

7★

WI-FI



REMOTE



CANAL.



Double

POT. 3,8 - 7,7 kW | 3,8 - 10,5 kW

7 | 10

# LISA

107  
45



AUTOMATIC  
CLEANING



CLEAN-GLASS  
SYSTEM



HIDDEN  
LOADING



PELLET  
OPTIMIZER



NOBIS SAFETY  
STANDARD



ECODESIGN  
2022

## Stufa a pellet a ventilazione frontale e canalizzazione posteriore opzionale.

Lisa è una stufa con scambiatore a fascio tubiero in acciaio inox, braciere autopulente e sistema di controllo della combustione. Comando della stufa tramite palmare touch o kit Wi-Fi opzionale.

## Pellet stove with front ventilation and optional rear canalization.

It is equipped with a stainless-steel tube-bundle heat exchanger, self-cleaning brazier and combustion-control system. The stove can be managed via remote control or Wi-Fi kit (optional).

## Poêle à granulés avec ventilation frontale et conduit arrière en option.

Lisa est un poêle équipé d'un échangeur de chaleur à faisceau de tubes en acier inoxydable, brasier autonettoyant et système de contrôle de la combustion. Le poêle peut être contrôlé par télécommande ou kit Wi-Fi (optionnel).

## Pelletofen mit Belüftung vorne und optionaler Kanalisierung hinten.

Er ist mit einem Rohrbündelwärmetauscher aus Edelstahl, einer selbstreinigenden Brennschale und einem Verbrennungskontrollsystem ausgestattet. Der Ofen kann per Fernbedienung oder WiFi-Kit (optional) gesteuert werden.



Bianco  
White  
Blanc  
Weiß



Nero  
Black  
Noir  
Schwarz



Bordeaux  
Bordeaux  
Bordeaux  
Bordeaux



Tortora  
Dove grey  
Gris tourterelle  
Taubengrau





PELLET

16 kg

WEIGHT

120 kg

ENERGY

A+

D.M. 186

★★★★

F.VERTE

7★

WI-FI

Optional

REMOTE

✓

CANAL.



Single



POT. 5,2 - 12,5 kW

12

# ELENA

119  
71 40



AUTOMATIC  
CLEANING



CLEAN-GLASS  
SYSTEM



HIDDEN  
LOADING



PELLET  
OPTIMIZER



NOBIS SAFETY  
STANDARD



ECODESIGN  
2022

## Stufa a pellet a ventilazione frontale e canalizzazione posteriore opzionale.

Elena è una stufa con scambiatore a fascio tubiero in acciaio inox, braciere autopulente e sistema di controllo della combustione. Comando della stufa tramite palmare touch o kit Wi-Fi opzionale.

## Pellet stove equipped with front ventilation and optional rear canalization.

This stove has a stainless-steel tube-bundle heat exchanger, self-cleaning brazier and combustion control system. The stove can be managed via remote control or Wi-Fi kit (optional).

## Poêle à granulés avec ventilation frontale et canalisation arrière en option.

Elena est un poêle équipé d'un échangeur à faisceau de tubes en acier inoxydable, brasier autonettoyant et système de contrôle de la combustion. Le poêle peut être contrôlé par télécommande ou kit Wi-Fi (optionnel).

## Pelletofen mit Belüftung vorne und optionaler Kanalisierung hinten.

Dieser Ofen verfügt über einen Rohrbündelwärmetauscher aus Edelstahl, eine selbstreinigende Brennschale und ein Verbrennungskontrollsystem. Der Ofen kann über eine Fernbedienung oder ein WiFi-Kit (optional) gesteuert werden.



Bianco  
White  
Blanc  
Weiß



Nero  
Black  
Noir  
Schwarz



Bordeaux  
Bordeaux  
Bordeaux  
Bordeaux



Tortora  
Dove grey  
Gris tourterelle  
Taubengrau

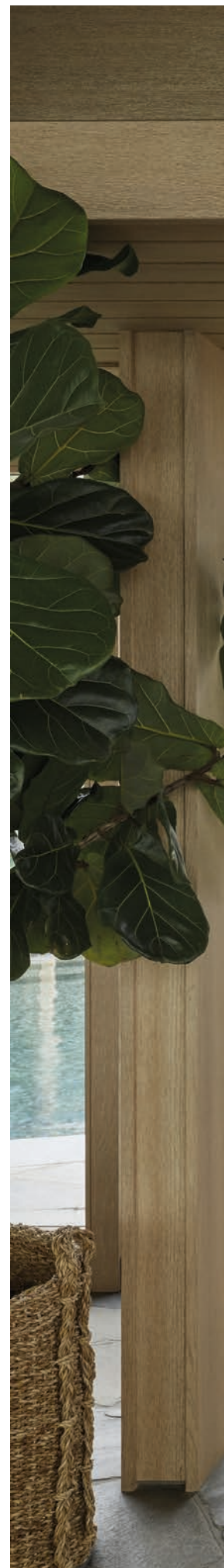



PELLET

23 kg

WEIGHT

130 kg

ENERGY

A+

D.M. 186

★★★★

F.VERTE

7★

WI-FI

Optional

REMOTE

✓

CANAL.



Single

12

## ELENA STYLE

119  
78 40



AUTOMATIC  
CLEANING



CLEAN-GLASS  
SYSTEM



HIDDEN  
LOADING



PELLET  
OPTIMIZER



NOBIS SAFETY  
STANDARD



ECODESIGN  
2022

### Stufa a pellet a ventilazione frontale e canalizzazione posteriore opzionale.

Elena è una stufa con scambiatore a fascio tubiero in acciaio inox, braciere autopulente e sistema di controllo della combustione. Comando della stufa tramite palmare touch o kit Wi-Fi opzionale.

### Pellet stove equipped with front ventilation and optional rear canalization.

This stove has a stainless-steel tube-bundle heat exchanger, self-cleaning brazier and combustion control system. The stove can be managed via remote control or Wi-Fi kit (optional).

### Poêle à granulés avec ventilation frontale et canalisation arrière en option.

Elena est un poêle équipé d'un échangeur à faisceau de tubes en acier inoxydable, brasier autonettoyant et système de contrôle de la combustion. Le poêle peut être contrôlé par télécommande ou kit Wi-Fi (optionnel).

### Pelletofen mit Belüftung vorne und optionaler Kanalisierung hinten.

Dieser Ofen verfügt über einen Rohrbündelwärmetauscher aus Edelstahl, eine selbstreinigende Brennschale und ein Verbrennungskontrollsystem. Der Ofen kann über eine Fernbedienung oder ein WiFi-Kit (optional) gesteuert werden.



Legno  
Wood  
Bois  
Wood



Bianco  
White  
Blanc  
Weiß



Nero  
Black  
Noir  
Schwarz





PELLET

23 kg

WEIGHT

130 kg

ENERGY

A+

D.M. 186

★★★★

F.VERTE

7★

WI-FI

Optional

REMOTE

✓

CANAL.



Single

## A11 | A13

# ROUND ROUND TOP ROUND TOP COAX

### ROUND



### ROUND TOP | TOP COAX



AUTOMATIC  
CLEANING



CLEAN-GLASS  
SYSTEM



HERMETIC  
CONSTRUCTION



HIDDEN  
LOADING



NATURAL  
CONVECTION



PELLET  
OPTIMIZER



NOBIS SAFETY  
STANDARD



ECODESIGN  
2022

**Stufa a pellet a convezione naturale e ventilazione frontale, con canalizzazione posteriore singola o doppia con kit opzionale.**

Round 11 e Round 13 sono stufe dal design moderno con doppia porta in vetro e laterale in acciaio verniciato. Pulizia automatica del braciore e sistema di caricamento pellet nascosto. Canalizzazione singola o doppia fino a 8 metri disponibile con kit. Wi-Fi di serie e palmare con funzione termostato ambiente.

**Poêle à granulés avec convection naturelle, ventilation frontale et canalisation arrière unique ou double (kit optionnel).**

Round est un poêle à granulés au design moderne, avec une porte en verre et côtés en acier peint. Il est équipé d'un système de nettoyage automatique du brasier et le chargement des granulés est caché à la vue. Un kit de canalisation simple ou double, jusqu'à 8 mètres, est aussi disponibles en option.

**Natural-convection pellet stove with front ventilation and single or double rear canalization kit (optional).**

This stove is characterized by modern design. It is equipped with glass door and painted steel sides, automatic brazier cleaning and hidden pellet-loading system. Thanks to our optional kit, single or double canalization, up to 8 meters, is also made available.

**Pelletofen mit natürlicher Konvektion, vorderer Belüftung und einfachem oder doppeltem Kanalisierungssatz an der Rückseite (optional).**

Dieser Ofen zeichnet sich durch modernes Design aus. Er ist mit einer Glastür und Seitenwänden aus lackiertem Stahl, einer automatischen Reinigung der Brennschale und einem versteckten Pellet-Ladesystem ausgestattet. Dank unseres optionalen Kits ist auch eine einfache oder doppelte Kanalisierung von bis zu 8 Metern möglich.



Bianco  
White  
Blanc  
Weiß

Nero  
Black  
Noir  
Schwarz

Bordeaux  
Bordeaux  
Bordeaux  
Bordeaux

Bronzo  
Bronze  
Bronze  
Bronze





PELLET

20 kg  
TOP 17 kg

WEIGHT

160 kg  
TOP 183 kg

ENERGY

A++  
A+

D.M. 186

★★★★★

F.VERTE

7★

WI-FI



REMOTE



CANAL.



Double



Single

## A11 | A13

# ROUND GLASS ROUND GLASS TOP ROUND GLASS TOP COAX

### ROUND



**Stufa a pellet con finitura in vetro a convezione naturale e ventilazione frontale, canalizzazione posteriore singola o doppia con kit opzionale.**

Stufa a pellet con pannelli laterali in vetro effetto carbonio, silver, nero e wengé. Doppia porta in vetro, pulizia automatica del braciere e sistema di caricamento pellet nascosto. Canalizzazione singola o doppia fino a 8 metri disponibile con kit opzionale. Wi-Fi di serie e palmare con funzione termostato ambiente.

**Poêle à granulés avec convection naturelle, ventilation frontale et canalisation arrière unique ou double (kit optionnel).**

Round est un poêle à granulés au design moderne, avec une porte en verre et côtés en acier peint. Il est équipé d'un système de nettoyage automatique du brasier et le chargement des granulés est caché à la vue. Un kit de canalisation simple ou double, jusqu'à 8 mètres, est aussi disponibles en option.

### ROUND TOP | TOP COAX



**Natural-convection pellet stove with front ventilation and single or double rear canalization kit (optional).**

This stove is characterized by modern design. It is equipped with glass door and painted steel sides, automatic brazier cleaning and hidden pellet-loading system. Thanks to our optional kit, single or double canalization, up to 8 meters, is also made available.

**Pelletofen mit natürlicher Konvektion, vorderer Belüftung und einfachem oder doppeltem Kanalisierungssatz an der Rückseite (optional).**

Dieser Ofen zeichnet sich durch modernes Design aus. Er ist mit einer Glastür und Seitenwänden aus lackiertem Stahl, einer automatischen Reinigung der Brennschale und einem versteckten Pellet-Ladesystem ausgestattet. Dank unseres optionalen Kits ist auch eine einfache oder doppelte Kanalisierung von bis zu 8 Metern möglich.



#### Carbon look

Carbon look  
Finition effet carbone  
Carbon look



#### Finitura Silver

Silver finish  
Finition couleur argent  
Silberfarbene Oberfläche



#### Black Glass

Black Glass finish  
Finition en verre noire  
Schwarze Glasoberfläche



#### Finitura Wengé Noir

Wenge Noir finishing  
Finition en wengé noir  
Wenge-Noir-Oberfläche

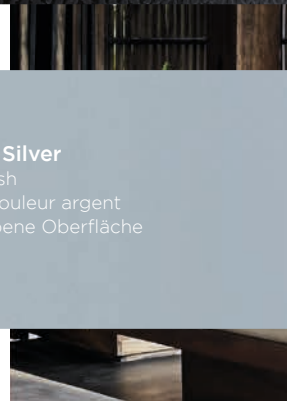



PELLET

20 kg  
TOP 17 kg

WEIGHT

160 kg  
TOP 183 kg

ENERGY



D.M. 186



F.VERTE



WI-FI



REMOTE



CANAL.



Double



Single



## A11 | A13

# ZENITH

121  
52



AUTOMATIC  
CLEANING



CLEAN-GLASS  
SYSTEM



HERMETIC  
CONSTRUCTION



HIDDEN  
LOADING



NATURAL  
CONVECTION



PELLET  
OPTIMIZER



NOBIS SAFETY  
STANDARD



ECODESIGN  
2022

**Stufa a pellet ermetica con scarico posteriore, a convezione naturale, ventilazione frontale escludibile e canalizzazione posteriore opzionale fino a 8 mt.**

Zenith è una stufa con rivestimento in acciaio verniciato e porta in vetro. È dotata di sistema automatico di controllo della combustione e braciere autopulente, comando della stufa con palmare e Wi-Fi di serie e motoriduttore brushless con tecnologia Silent.

**Poêle à granulés hermétique avec conduit de fumée arrière, convection naturelle, ventilation frontale désactivable et conduit arrière optionnel jusqu'à 8 mètres.**

Bardage en acier peint et porte en verre. Équipé d'un système de contrôle automatique de la combustion, d'un brasier autonettoyant, d'une télécommande et connexion Wi-Fi (fournis en standard) et d'un motoréducteur sans balais équipé de la technologie Silent.

**Hermetic pellet stove with rear exhaust pipe, natural convection, front ventilation (which can be deactivated) and optional rear canalization up to 8 meters.**

Painted steel cladding and glass door. Equipped with automatic combustion-control system and self-cleaning brazier, remote control and Wi-Fi connection (supplied as standard), brushless gearmotor equipped with Silent technology.

**Hermetischer Pelletofen mit hinterem Abgasrohr, natürlicher Konvektion, vorderer Belüftung (deaktivierbar) und optionaler hinterer Kanalisierung bis zu 8 Metern.**

Verkleidung aus lackiertem Stahl und Glastür. Ausgestattet mit automatischem Verbrennungskontrollsystem und selbstreinigender Brennschale, Fernbedienung und WiFi-Verbindung (im Lieferumfang enthalten), bürstenlosem Getriebemotor mit Silent Technology.



Bianco  
White  
Blanc  
Weiß



Nero  
Black  
Noir  
Schwarz



Bordeaux  
Bordeaux  
Bordeaux  
Bordeaux



Bronzo  
Bronze  
Bronze  
Bronze



PELLET

22 kg

WEIGHT

183 kg

ENERGY



D.M. 186



F.VERTE



WI-FI



REMOTE



CANAL.



Double

A11 | A13

# ZENITH PLUS



AUTOMATIC  
CLEANING



CLEAN-GLASS  
SYSTEM



HERMETIC  
CONSTRUCTION



HIDDEN  
LOADING



NATURAL  
CONVECTION



PELLET  
OPTIMIZER



NOBIS SAFETY  
STANDARD



ECODESIGN  
2022

**Stufa a pellet ermetica con scarico posteriore, a convezione naturale, ventilazione frontale escludibile e canalizzazione posteriore opzionale fino a 8 mt.**

Zenith è una stufa con rivestimento in acciaio verniciato e porta in vetro. È dotata di sistema automatico di controllo della combustione e braciere autopulente, comando della stufa con palmare e Wi-Fi di serie e motoriduttore brushless con tecnologia Silent.

**Poêle à granulés hermétique avec conduit de fumée arrière, convection naturelle, ventilation frontale désactivable et conduit arrière optionnel jusqu'à 8 mètres.**

Bardage en acier peint et porte en verre. Équipé d'un système de contrôle automatique de la combustion, d'un brasier autonettoyant, d'une télécommande et connexion Wi-Fi (fournis en standard) et d'un motoréducteur sans balais équipé de la technologie Silent.

**Hermetic pellet stove with rear exhaust pipe, natural convection, front ventilation (which can be deactivated) and optional rear canalization up to 8 meters.**

Painted steel cladding and glass door. Equipped with automatic combustion-control system and self-cleaning brazier, remote control and Wi-Fi connection (supplied as standard), brushless gearmotor equipped with Silent technology.

**Hermetischer Pelletofen mit hinterem Abgasrohr, natürlicher Konvektion, vorderer Belüftung (deaktivierbar) und optionaler hinterer Kanalisierung bis zu 8 Metern.**

Verkleidung aus lackiertem Stahl und Glastür. Ausgestattet mit automatischem Verbrennungskontrollsystem und selbstreinigender Brennschale, Fernbedienung und WiFi-Verbindung (im Lieferumfang enthalten), bürstenlosem Getriebemotor mit Silent Technology.



Bianco  
White  
Blanc  
Weiß



Nero  
Black  
Noir  
Schwarz



Bordeaux  
Bordeaux  
Bordeaux  
Bordeaux



Bronzo  
Bronze  
Bronze  
Bronze





PELLET

22 kg

WEIGHT

183 kg

ENERGY



D.M. 186



F.VERTE



WI-FI



REMOTE



CANAL.



Double

nobis

# ULISSE



CAMINI / INSERTS / CHEMINÉES / EINSÄTZE

Ventilazione frontale

*Front ventilation / Ventilation frontale /  
Belüftung vorne*

Ampia visione della fiamma

*Enjoy the view of the flame /  
Grande visibilité de la flamme /  
Genießen Sie den Blick auf die Flamme*



Supporto opzionale

*Optional floor support / Support en option  
/ Optionale Bodenunterstützung*

## Aria e acqua

*Air and water / Aire et eau / Luft und Wasser*

Riscalda la casa in libertà con la ventilazione frontale o con inserti a acqua da integrare all'impianto esistente.

Integrated front ventilation systems and fireplace inserts to enjoy home heating to the full.

Ventilation forcée ou inserts à granulés pour une chaleur immédiate et diffuse dans l'environnement de l'installation.

Integrierte Frontlüftungssysteme und Kamineinsätze für vollen Heizgenuss im Haus.

## Fiamma ampia

*Greater flame / Large flamme / Größere Flamme*

L'ampio vetro permette la visione totale della fiamma per una piacevole sensazione del focolare secondo tradizione.

A wide glass door for a complete view of the flame to relive the pleasure of traditional households.

Une large porte vitrée pour une vision complète de la flamme: revivez le plaisir des foyers traditionnels.

Eine breite Glastür für einen vollständigen Blick auf die Flamme, um das Vergnügen traditioneller Haushalte wieder aufleben zu lassen.

## Caricamento facilitato

*Easy loading / Chargement aisé / Einfaches Laden*

Il caricamento pellet è agevolato dall'installazione opzionale di un serbatoio superiore disponibile con caricamento frontale o laterale.

An optional top pellet tank with front or side opening is made available to facilitate refilling.

Un réservoir à pellets supérieur (optionnel) avec ouverture frontale ou latérale est mis à disposition pour faciliter le remplissage.

Um das Nachfüllen zu erleichtern, ist ein optionaler oberer Pellettank mit vorderer oder seitlicher Öffnung erhältlich.



### Montaggio e manutenzione facilitata

Il corpo macchina degli inserti Nobis è totalmente estraibile per consentire un montaggio rapido e facilitare tutte le operazioni di manutenzione ordinaria e straordinaria.

### Easy assembly, and maintenance

Nobis inserts are completely removable to facilitate assembly and maintenance operation.

### Assemblage et entretien faciles

Les inserts Nobis sont entièrement démontables pour faciliter le montage et toute operation d'entretien.

### Einfache Montage und Wartung

Nobis-Einsätze sind vollständig abnehmbar, um Montage- und Wartungsarbeiten zu erleichtern.

POT. 4,0 - 9,9 kW

B10 V

# ULISSE

50  
69

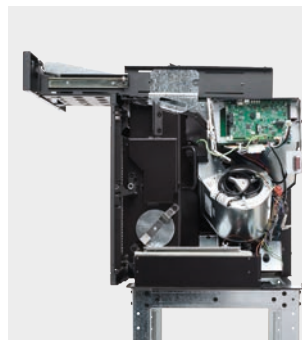

## Inserto a pellet a ventilazione frontale con motoriduttore brushless di serie.

Cassetto di caricamento frontale o laterale opzionali, supporto in acciaio opzionale. Comando dell'inserto tramite palmare con funzione di termostato ambiente o con Wi-Fi tramite kit optional.

## Pellet insert equipped with front ventilation and brushless motor as standard.

Optional front or side loading drawer and steel floor support. The insert can be managed via remote control (equipped with thermostat control function) or else via Wi-Fi (optional kit).

## Insert à granulés avec ventilation frontale et motoréducteur de série.

Tiroir à chargement frontal ou latéral et support en acier en option. L'insert peut être contrôlé par télécommande avec fonction de thermostat d'ambiance ou kit Wi-Fi (optionnel).

## Pelleteinsatz serienmäßig mit Frontbelüftung und bürstenlosem Motor ausgestattet.

Optionale Front- oder Seitenladeschublade und Bodenstütze aus Stahl. Der Einsatz kann per Fernbedienung (ausgestattet mit Thermostat-Steuerfunktion) oder über WIFI(optionales Kit) gesteuert werden.



CLEAN-GLASS SYSTEM



PELLET OPTIMIZER



NOBIS SAFETY STANDARD



ECODESIGN 2022

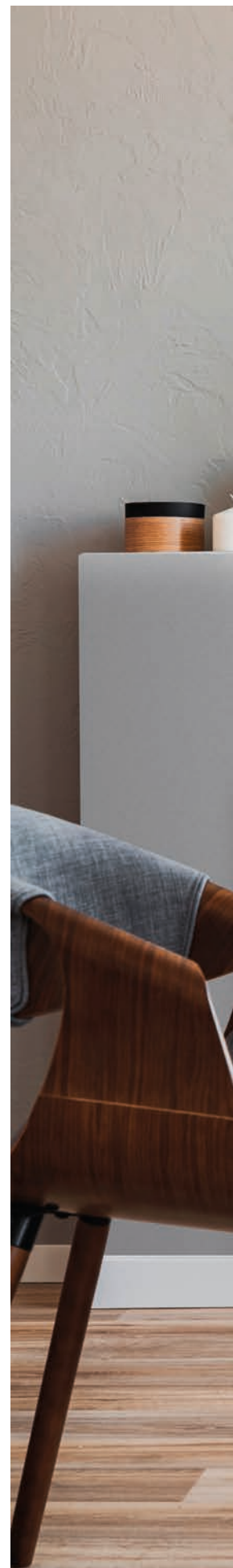



PELLET

12 kg

WEIGHT

95 kg

ENERGY

A+

D.M. 186

★★★★★

F.VERTE

7★

WI-FI

Optional

REMOTE





POT. 4,0 - 9,9 kW

B10 C

# ULISSE



### Inserto a pellet canalizzato, ventilazione frontale e motoriduttore brushless.

Cassetto di caricamento frontale o laterale opzionali, supporto in acciaio opzionale. Comando dell'inserto tramite palmare con funzione di termostato ambiente o con Wi-Fi tramite kit optional.

### Pellet insert equipped with canalization, front ventilation and brushless motor.

Optional front or side loading drawer and steel floor support. The insert can be managed via remote control (equipped with thermostat control function) or else via Wi-Fi (optional kit).

### Insert à granulés canalisé avec ventilation frontale et motoréducteur.

Tiroir à chargement frontal ou latéral et support en acier en option. L'insert peut être contrôlé par télécommande avec fonction de thermostat d'ambiance ou kit Wi-Fi (optionnel).

### Pelleteinsatz ausgestattet mit Kanalisierung, Frontbelüftung und bürstenlosem Motor.

Optionale Front- oder Seitenladeschublade und Bodenstütze aus Stahl. Der Einsatz kann per Fernbedienung (ausgestattet mit Thermostat-Steuerfunktion) oder über WiFi (optionales Kit) gesteuert werden.



CLEAN-GLASS SYSTEM



PELLET OPTIMIZER



NOBIS SAFETY STANDARD



ECODESIGN 2022

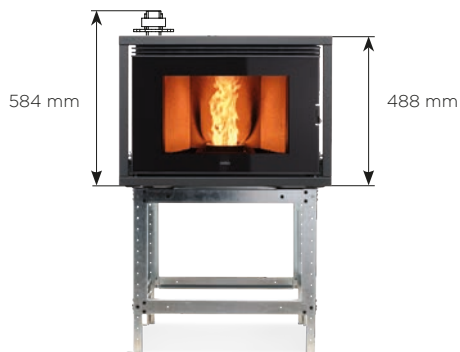



PELLET

14 kg

WEIGHT

110 kg

ENERGY

A+

D.M. 186

★★★★★

F.VERTE

7★

WI-FI

Optional

REMOTE



CANAL.



Single

POT. 5,2 - 12,5 kW

B13 V

# ULISSE

120  
83

## Camino monoblocco a pellet canalizzato, ventilazione frontale e motoriduttore brushless.

Comando del camino tramite palmare con funzione di termostato ambiente o con Wi-Fi incluso. Finitura in gres effetto marmo, dark e grey.

## Insert à granulés avec canalisation, ventilation frontale et motoréducteur de série.

L'insert peut être contrôlé par télécommande avec fonction de thermostat d'ambiance ou kit Wi-Fi. Disponible dans finitions en grès foncé, grey ou effet marbre.

## Single-piece pellet insert equipped with canalization, front ventilation and brushless motor.

Optional front or side loading drawer and steel floor support. The insert can be managed via remote control (equipped with thermostat control function) or else via Wi-Fi. Available with dark, grey, or marble-effect stoneware finishes.

## Einteiliger Pelleteinsatz mit Kanalisierung, Frontbelüftung und bürstenlosem Motor.

Optionale Front- oder Seitenladeschublade und Bodenstütze aus Stahl. Der Einsatz kann per Fernbedienung (mit Thermostat-Steuerfunktion ausgestattet) oder per WiFi gesteuert werden. Erhältlich mit dunklen, Marmoroptik Steinzeugoberflächen.



AUTOMATIC  
CLEANING



CLEAN-GLASS  
SYSTEM



HIDDEN  
LOADING



PELLET  
OPTIMIZER



NOBIS SAFETY  
STANDARD



ECODESIGN  
2022



Carrara



Dark



Grey





PELLET

35 kg

WEIGHT

160 kg

ENERGY



D.M. 186



F.VERTE



WI-FI



REMOTE



CANAL.



Double

TERMOSTUFE | THERMOSTOVES | THERMOPOÊLES | THERMOÖFEN



**ACQUA**  
LA FORZA DELL'ACQUA

## Braciere autopulente

*Self-cleaning brazier / Brasier autonettoyant / Selbstreinigende Kohlenpfanne*

In soli 15 minuti la stufa si spegne, si pulisce e si riaccende in maniera completamente automatica evitando il raffreddamento degli scambiatori.

The stove switches off, cleans itself and switches back on automatically in just 15 minutes, thus preventing heat exchangers from cooling down.

En seulement 15 minutes, le poêle s'éteint, se nettoie et se rallume de manière autonome, évitant le refroidissement des échangeurs.

Der Ofen schaltet sich ab, reinigt sich selbst und schaltet sich in nur 15 Minuten automatisch wieder ein und verhindert so ein Auskühlen der Wärmetauscher.

## Ventilazione frontale

*Front ventilation / Ventilation frontale / Belüftung frontal*

Ventilazione forzata con motore tangenziale completamente escludibile per un calore immediato e diffuso nell'ambiente di installazione.

Forced ventilation with tangential motor (which can be deactivated completely) for immediate and diffused heat in the installation environment.

Ventilation forcée avec moteur tangentiel entièrement désactivable pour une chaleur immédiate et diffuse dans l'environnement de l'installation.

Zwangsbelüftung mit Tangentialmotor (vollständig abschaltbar) für sofortige und diffuse Wärme in der Installationsumgebung.

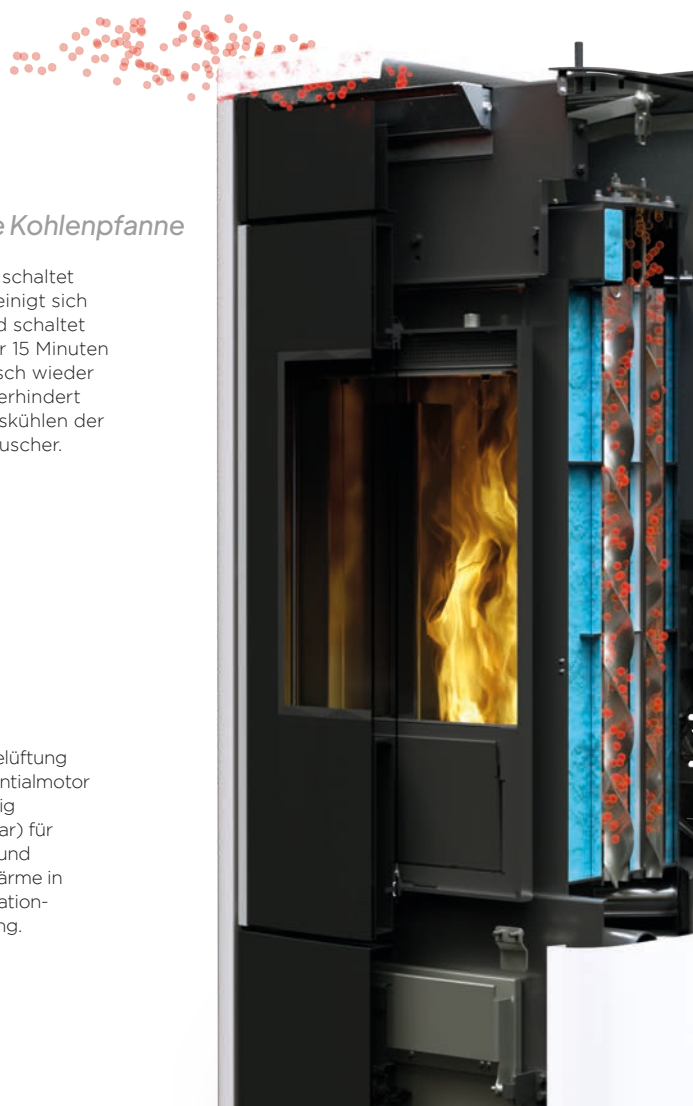

## Pulizia automatica dei turbolatori

*Turbulators automatic cleaning / Nettoyage automatique des turbulateurs / Automatische Reinigung der Turbulatoren*

Le termostufe sono dotate di pulizia automatica dei turbolatori. Un bilanciere gestito dall'elettronica muove automaticamente le spirali e pulisce il fascio tubiero. Le ceneri vengono smaltite nel cassetto cenere e lo scambio termico resta ottimale.

Our thermostoves are equipped with automatic cleaning of the turbulators. An electronical balance wheel managed automatically moves the spirals to clean the tube bundle, and ashes are disposed of in the ash drawer to ensure optimal heat exchange.

Nos thermopoêles sont équipés d'un système de nettoyage automatique des turbulateurs. Un balancier géré électroniquement déplace les spirales automatiquement pour nettoyer le faisceau de tubes et les cendres sont éliminées dans le tiroir à cendres pour assurer un échange thermique optimal.

Unsere Thermoöfen sind mit einer automatischen Reinigung der Turbulatoren ausgestattet. Eine elektronisch gesteuerte Radwaage bewegt die Spiralen automatisch, um das Rohrbündel zu reinigen, und die Asche wird in der Ascheschublade entsorgt, um einen optimalen Wärmeaustausch zu gewährleisten.

POT. 8,8 - 18,9 kW | 8,8 - 21,2 kW ◊ 6,6 - 14,6 kW | 6,6 - 16,9 kW

HB14 | HB17

# ULISSE

120  
83



## Termocamino a pellet con ventilazione frontale e motoriduttore brushless.

Comando del camino tramite palmare con funzione di termostato ambiente o con Wi-Fi tramite kit incluso. Finitura in effetto legno noce, bianco e nero, o in gres effetto marmo, dark e grey.

## Pellet thermo-insert equipped with canalization, front ventilation and brushless motor.

The insert can be managed via remote control (equipped with thermostat control function) or else via Wi-Fi (optional kit). Available with white or black walnut wood effect finishes, or dark, grey, or marble-effect stoneware finishes.

## Insert à pellets canalisé à ventilation frontale équipé avec motoréducteur sans balais.

L'insert peut être contrôlé par télécommande avec fonction de thermostat d'ambiance ou kit Wi-Fi (optionnel). Disponible dans finitions en effet bois de noyer blanc ou noir, ou encore en grès foncé, grey ou effet marbre.

## Pellet-Thermoeinsatz mit Kanalisierung, Frontbelüftung und bürstenlosem Motor.

Der Einsatz kann über eine Fernbedienung (ausgestattet mit Thermostat-Steuerfunktion) oder über WiFi (optionales Kit) gesteuert werden. Erhältlich in den Ausführungen Weiß- oder Schwarzwalnut-Holzeffekt oder in den Ausführungen Dunkel-, Grey- oder Marmoroptik-Steinzeug.



AUTOMATIC  
CLEANING



CLEAN-GLASS  
SYSTEM



HIDDEN  
LOADING



PELLET  
OPTIMIZER



NOBIS SAFETY  
STANDARD



ECODESIGN  
2022



Legno Noce  
Wood Walnut  
Wood Noix  
Holz Walnuss



Legno Nero  
Wood Black  
Wood Noir  
Holz Schwarz



Legno Bianco  
Wood White  
Wood Blanc  
Holz Weiß



Carrara



Dark



Grey





PELLET

28 kg

WEIGHT

220 kg

ENERGY

A++

D.M. 186

★★★★★

F. VERTE

7★

WI-FI

✓

REMOTE

✓



POT. 8,8 - 18,9 kW | 8,8 - 21,2 kW    ◊ 6,6 - 14,6 kW | 6,6 - 16,9 kW



#### Sistema di caricamento superiore facilitato

Easy-to-use top loading system  
Système de chargement supérieure facile à utiliser  
Einfach zu bedienendes Topladersystem

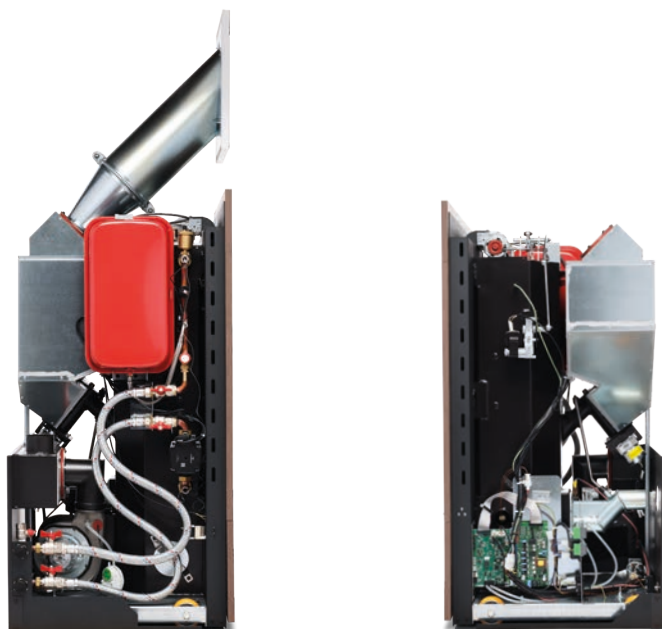

#### Vaso di espansione da 12 litri

12L expansion vessel  
Vaisseau d'expansion de 12L  
12L Ausdehnungsgefäß

#### Capacità serbatoio

Tank capacity  
Capacité du réservoir  
Tankinhalt



PELLET

28 kg

WEIGHT

220 kg

ENERGY

A++

D.M. 186

★★★★★

F.VERTE

7★

WI-FI



REMOTE



POT. 6,8 - 14,2 kW | 6,8 - 16,8 kW  $\diamond$  4,8 - 10 kW | 4,8 - 12 kW

# H10 | H12

## SHAPE

113  
53 60



### Termostufa a pellet con ventilazione frontale completamente disattivabile.

Rivestimento in acciaio verniciato e maiolica, motoriduttore brushless di serie con braciere autopulente e tecnologia Perfect di controllo della combustione. Controllo della stufa da palmare con funzione termostato o tramite kit Wi-Fi di serie.

### Pellet thermo-stove with front ventilation (it can be deactivated completely).

Painted steel and majolica cladding, standard brushless gearmotor with self-cleaning brazier and Perfect combustion-control technology. The product can be managed via remote control, equipped with thermostat control function, or Wi-Fi kit (supplied as standard).

### Thermopoêle à granulés avec ventilation frontale entièrement désactivable.

Bardage en acier peint et majolique, motoréducteur sans balais de série avec brasier autonettoyant et technologie de contrôle de la combustion Perfect. Le produit peut être contrôlé par télécommande avec fonction de thermostat d'ambiance ou kit Wi-Fi de série.

### Pellet-Thermoofen mit Frontbelüftung (komplett abschaltbar).

Verkleidung aus lackiertem Stahl und Majolika, serienmäßiger bürstenloser Getriebemotor mit selbstreinigender Brennschale und Perfect-Verbrennungskontrolltechnologie. Das Produkt kann über eine Fernbedienung gesteuert werden, die mit einer Thermostatkontrollfunktion ausgestattet ist, oder über ein WiFi-Kit (im Lieferumfang enthalten).



AUTOMATIC CLEANING



CLEAN-GLASS SYSTEM



HIDDEN LOADING



PELLET OPTIMIZER



NOBIS SAFETY STANDARD



ECODESIGN 2022



Bianco  
White  
Blanc  
Weiß



Nero  
Black  
Noir  
Schwarz



Bordeaux  
Bordeaux  
Bordeaux  
Bordeaux



Nocciola  
Hazelnut  
Noisette  
Haselnuss

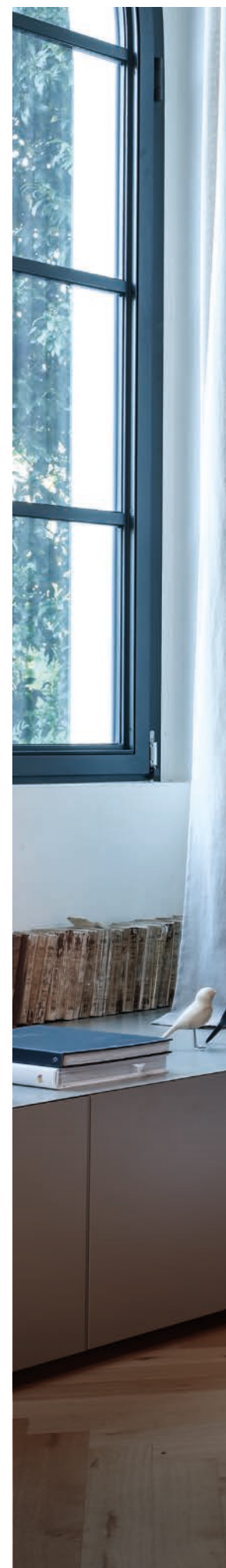



PELLET

20 kg

WEIGHT

165 kg

ENERGY

A++

D.M. 186

★★★★

F.VERTE

7★

WI-FI



REMOTE



POT. 6,8 - 14,2 kW | 6,8 - 16,8 kW    ◊ 4,8 - 10 kW | 4,8 - 12 kW

H10 | H12

# SHAPE GLASS

113  
53 60

## Termostufa a pellet con ventilazione frontale completamente disattivabile.

Rivestimento in vetro con finitura carbon look, wengé noir, silver e black. Motoriduttore brushless di serie con braciere autopulente e tecnologia Perfect di controllo della combustione. Controllo della stufa da palmare con funzione termostato o tramite kit Wi-Fi di serie.

## Thermopoêle à granulés avec ventilation frontale entièrement désactivable.

Panneaux latéraux en verre en finition effet carbone, wengé noir, argent et noir. Motoréducteur sans balais de série avec brasier autonettoyant et technologie Perfect pour le contrôle de la combustion. Le produit peut être contrôlé par télécommande avec fonction de thermostat d'ambiance ou kit Wi-Fi de série.

## Pellet thermo-stove with front ventilation (it can be deactivated completely).

Glass side panels in carbon-fiber look, wengé noir, silver and black finishes. Brushless motor supplied as standard with self-cleaning brazier and Perfect combustion-control technology. The product can be managed via remote control, equipped with thermostat control function, or Wi-Fi kit (supplied as standard).

## Pellet-Thermoofen mit Frontbelüftung (komplett abschaltbar).

Seitenteile aus Glas in Carbonoptik, in den Ausführungen Wenge Noir, Silber und Schwarz. Bürstenloser Motor, serienmäßig mit selbstreinigender Brennschale und Perfect-Verbrennungskontrolltechnologie. Das Produkt kann über eine Fernbedienung gesteuert werden, die mit einer Thermostatkontrollfunktion, oder WiFi-Kit (im Lieferumfang enthalten) ausgestattet ist.



### Carbon look

Carbon look  
Finition effet carbone  
Carbon look



### Finitura Silver

Silver finishing  
Finition couleur argent  
Silberfarbene Oberfläche



### Black Glass

Black Glass finishing  
Finition en verre noir  
Schwarze Glasoberfläche



### Finitura Wengé Noir

Wenge Noir finishing  
Finition en wengé noir  
Wenge-Noir-Oberfläche



AUTOMATIC  
CLEANING



CLEAN-GLASS  
SYSTEM



HIDDEN  
LOADING



PELLET  
OPTIMIZER



NOBIS SAFETY  
STANDARD



ECODESIGN  
2022



PELLET

20 kg

WEIGHT

165 kg

ENERGY

A++

D.M. 186

★★★★

F.VERTE

7★

WI-FI



REMOTE



H14 | H17

# SHAPE STEEL



## Termostufa a pellet con ventilazione frontale completamente disattivabile.

Rivestimento in acciaio verniciato, motoriduttore brushless di serie con pulizia automatica del braciere e dei turbolatori. Controllo della stufa da palmare con funzione termostato ambiente o tramite kit Wi-Fi di serie.

## Pellet thermo-stove with front ventilation (it can be deactivated completely).

Painted steel cladding, brushless gearmotor with self-cleaning brazier supplied as standard and Perfect combustion-control technology. The product can be managed via remote control, equipped with thermostat control function, or Wi-Fi kit (supplied as standard).

## Thermopoêle à granulés avec ventilation frontale entièrement désactivable.

Bardage en acier peint et majolique, motoréducteur sans balais de série avec brasier autonettoyant et technologie de contrôle de la combustion Perfect. Le produit peut être contrôlé par télécommande avec fonction de thermostat d'ambiance ou kit Wi-Fi de série.

## Pellet-Thermoofen mit Frontbelüftung (komplett abschaltbar).

Verkleidung aus lackiertem Stahl, bürstenloser Getriebemotor mit selbstreinigender Brennschale im Lieferumfang enthalten und Perfect Verbrennungskontrolltechnologie. Das Produkt kann über eine Fernbedienung gesteuert werden, die mit einer Thermostatkontrollfunktion, oder WiFi-Kit (im Lieferumfang enthalten) ausgestattet ist.



AUTOMATIC CLEANING



CLEAN-GLASS SYSTEM



HIDDEN LOADING



PELLET OPTIMIZER



NOBIS SAFETY STANDARD



ECODESIGN 2022



Bianco  
White  
Blanc  
Weiß



Nero  
Black  
Noir  
Schwarz



Bordeaux  
Bordeaux  
Bordeaux  
Bordeaux



Bronzo  
Bronze  
Bronze  
Bronze





PELLET

21 kg

WEIGHT

185 kg  
H17 220 kg

ENERGY

A++

D.M. 186

★★★★★

F.VERTE

7★

WI-FI



REMOTE





H14 | H17

# SHAPE ROUND



## Termostufa a pellet con ventilazione frontale completamente disattivabile.

Rivestimento in acciaio verniciato, motoriduttore brushless di serie con pulizia automatica del braciere e dei turbolatori. Controllo della stufa da palmare con funzione termostato ambiente o tramite kit Wi-Fi di serie.

## Pellet thermo-stove with front ventilation (it can be deactivated completely).

Painted steel cladding, brushless gearmotor supplied as standard with self-cleaning brazier and turbulators. The product can be managed via remote control, equipped with thermostat control function, or Wi-Fi kit (supplied as standard).

## Thermopoêle à granulés avec ventilation frontale entièrement désactivable.

Bardage en acier peint et majolique, motoréducteur sans balais de série avec brasier et turbulateurs autonettoyants. Le produit peut être contrôlé par télécommande avec fonction de thermostat d'ambiance ou kit Wi-Fi de série.

## Pellet-Thermoofen mit Frontbelüftung (komplett abschaltbar).

Verkleidung aus lackiertem Stahl, bürstenloser Getriebemotor, standardmäßig mit selbstreinigender Brennschale und Turbulatoren ausgestattet. Das Produkt kann über eine Fernbedienung gesteuert werden, die mit einer Thermostatkontrollfunktion, oder WiFi-Kit (im Lieferumfang enthalten) ausgestattet ist.



AUTOMATIC CLEANING



CLEAN-GLASS SYSTEM



HIDDEN LOADING



PELLET OPTIMIZER



NOBIS SAFETY STANDARD



ECODESIGN 2022



Bianco  
White  
Blanc  
Weiß



Nero  
Black  
Noir  
Schwarz



Bordeaux  
Bordeaux  
Bordeaux  
Bordeaux



Bronzo  
Bronze  
Bronze  
Bronze





PELLET

22 kg

WEIGHT

185 kg

ENERGY

A++

D.M. 186

★★★★★

F.VERTE

7★

WI-FI



REMOTE



POT. 8,5 - 21,6 kW

Ø 6,4 - 17,0 kW

H17

# LIGHT



## Termostufa a pellet a profondità ridotta, ventilazione frontale completamente escludibile e rivestimento legno.

Motoriduttore brushless, pulizia automatica del braciere e dei turbolatori. Comando della stufa tramite display con funzione di termostato ambiente o Wi-Fi di serie integrato.

## Thermopoêle à granulés compact, à profondeur réduite pour une installation dans des espaces restreints, ventilation frontale (entièrement désactivable) et bardage effet bois.

Motoréducteur sans balais de série avec technologie Silent, brasier autonettoyant, système de contrôle automatique de la combustion, nettoyage automatique des turbulateurs. Le poêle peut être contrôlé par télécommande avec fonction de thermostat d'ambiance ou kit Wi-Fi de série.

## Compact pellet thermostove with reduced depth for installation in space-constrained areas, front ventilation (which can be completely deactivated) and wood-effect cladding.

Brushless gearmotor supplied as standard, equipped with Silent technology, self-cleaning brazier, automatic combustion-control system, automatic turbulator cleaning. The stove can be managed via remote control with thermostat control function or integrated Wi-Fi (supplied as standard).

## Kompakter Pellet-Thermoofen mit reduzierter Tiefe für den Einbau in Räumen mit begrenztem Platzangebot, Frontlüftung (vollständig deaktivierbar) und Verkleidung in Holzoptik.

Serienmäßig mit bürstenlosem Getriebemotor ausgestattet, mit Silent Technology, selbstreinigender Brennschale, automatischem Verbrennungskontrollsystem und automatischer Turbulatorreinigung. Der Ofen kann über eine Fernbedienung mit Thermostatsteuerungsfunktion oder integriertes WiFi (serienmäßig im Lieferumfang enthalten) gesteuert werden.



AUTOMATIC  
CLEANING



CLEAN-GLASS  
SYSTEM



HIDDEN  
LOADING



PELLET  
OPTIMIZER



NOBIS SAFETY  
STANDARD



ECODESIGN  
2022



Legno noce  
Wood walnut  
Wood noix  
Holz Walnuss



Legno nero  
Wood black  
Wood noir  
Holz Schwarz



Legno bianco  
Wood white  
Wood blanc  
Holz Weiß





PELLET

25 kg

WEIGHT

210 kg

ENERGY

A++

D.M. 186

★★★★

F.VERTE

7★

WI-FI



REMOTE



POT. 8,5 - 21,6 kW

Ø 6,4 - 17,0 kW



### Finitura in legno e con vetro oscurato e doppia porta

Wooden finish with tinted glass and double door  
Finition en bois avec verre teinté et double porte  
Holzausführung mit getöntem Glas und Doppeltür



### Caricamento pellet facilitato

Easy pellet loading  
Chargement facile des granulés  
Einfache Pelletbeladung



### Doppia porta in vetro

Double glass door  
Porte à double vitrage  
Doppelglastür



AUTOMATIC  
CLEANING



CLEAN-GLASS  
SYSTEM



HIDDEN  
LOADING



PELLET  
OPTIMIZER



NOBIS SAFETY  
STANDARD



ECODESIGN  
2022



PELLET

25 kg

WEIGHT

210 kg

ENERGY

A++

D.M. 186

★★★★

F.VERTE

7★

WI-FI



REMOTE



POT. 8,8 - 21,2 kW

◇ 6,6 - 16,9 kW

H17

# SHAPE MAIOLICA



## Termostufa a pellet con ventilazione frontale completamente disattivabile.

Rivestimento in acciaio verniciato o maiolica, motoriduttore brushless di serie, pulizia automatica del braciere e dei turbolatori. Controllo della stufa da palmare con funzione termostato ambiente o tramite kit Wi-Fi di serie.

## Thermopoêle à granulés avec ventilation frontale entièrement désactivable.

Bardage en acier peint or majolique, motoréducteur sans balais de série avec brasier autonettoyant et technologie Perfect pour le contrôle de la combustion. Le poêle peut être contrôlé par télécommande avec fonction de thermostat d'ambiance ou kit Wi-Fi de série.

## Pellet thermo-stove with front ventilation, which can be deactivated completely.

Painted steel or ceramic cladding, brushless gearmotor supplied as standard with self-cleaning brazier and Perfect combustion-control technology. The product can be managed via remote control, equipped with thermostat control function, or Wi-Fi kit (supplied as standard).

## Pellet-Thermoofen mit Frontlüftung, die komplett deaktiviert werden kann.

Verkleidung aus lackiertem Stahl oder Keramik, bürstenloser Getriebemotor, serienmäßig mit selbstreinigender Brennschale und Perfect-Verbrennungskontrolltechnologie. Das Produkt kann über eine Fernbedienung gesteuert werden, die mit einer Thermostatkontrollfunktion, oder WiFi-Kit (im Lieferumfang enthalten) ausgestattet ist.



AUTOMATIC  
CLEANING



CLEAN-GLASS  
SYSTEM



HIDDEN  
LOADING



PELLET  
OPTIMIZER



NOBIS SAFETY  
STANDARD



ECODESIGN  
2022



Bianco  
White  
Blanc  
Weiß



Nero  
Black  
Noir  
Schwarz



Bordeaux  
Bordeaux  
Bordeaux  
Bordeaux



Nocciola  
Hazelnut  
Noisette  
Haselnuss

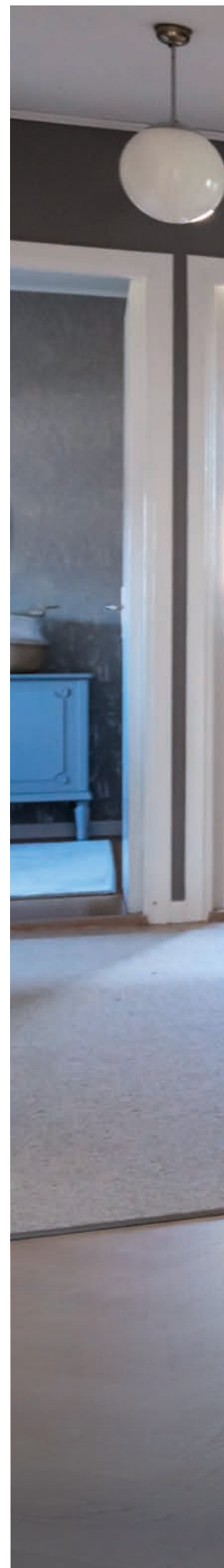



PELLET

21 kg

WEIGHT

220 kg

ENERGY

A++

D.M. 186

★★★★★

F.VERTE

7★

WI-FI



REMOTE





POT. 12,6 - 25 kW

Ø 10,6 - 20,5 kW

H20

# SHAPE SHAPE STEEL

130  
57 66



### Termostufa a pellet con ventilazione frontale completamente disattivabile.

Rivestimento in acciaio verniciato o maiolica, motoriduttore brushless di serie, pulizia automatica del braciere e dei turbolatori. Controllo della stufa da palmare con funzione termostato ambiente o tramite kit Wi-Fi di serie.

### Thermopoêle à granulés avec ventilation frontale entièrement désactivable.

Bardage en acier peint ou majolique, motoréducteur sans balais de série avec brasier et turbulateurs. Le poêle peut être contrôlé par télécommande avec fonction thermostat d'ambiance ou kit Wi-Fi de série.

### Pellet thermo-stove with front ventilation, which can be deactivated completely.

Painted steel or ceramic cladding, brushless gearmotor supplied as standard with self-cleaning brazier and turbulators. The product can be managed via remote control, equipped with thermostat control function, or Wi-Fi kit (supplied as standard).

### Pellet-Thermoofen mit Frontlüftung, die komplett deaktiviert werden kann.

Verkleidung aus lackiertem Stahl oder Keramik, bürstenloser Getriebemotor, standardmäßig mit selbstreinigender Brennschale und Turbulatoren ausgestattet. Das Produkt kann über eine Fernbedienung gesteuert werden, die mit einer Thermostatkontrollfunktion, oder WiFi-Kit (im Lieferumfang enthalten) ausgestattet ist.



AUTOMATIC  
CLEANING



CLEAN-GLASS  
SYSTEM



HIDDEN  
LOADING



PELLET  
OPTIMIZER



NOBIS SAFETY  
STANDARD



ECODESIGN  
2022



#### MAIOLICA

Bianco / White / Blanc / Weiß  
Nero / Black / Noir / Schwarz  
Bordeaux / Bordeaux / Bordeaux / Bordeaux  
Nocciola / Hazelnut / Noisette / Haselnuss

#### STEEL

Bianco / White / Blanc / Weiß  
Nero / Black / Noir / Schwarz  
Bordeaux / Bordeaux / Bordeaux / Bordeaux  
Bronzo / Bronze / Bronze / Bronze





PELLET

37 kg

WEIGHT

260 kg

ENERGY

A+

D.M. 186

★★★★★

F.VERTE

7★

WI-FI

✓

REMOTE

✓

POT. 12,6 - 28,2 kW

Ø 10,6 - 23,4 kW

H25

# SHAPE SHAPE STEEL

130  
57 66

### Termostufa a pellet con ventilazione frontale completamente disattivabile.

Rivestimento in acciaio verniciato o maiolica, motoriduttore brushless di serie, pulizia automatica del braciere e dei turbolatori. Controllo della stufa da palmare con funzione termostato ambiente o tramite kit Wi-Fi di serie.

### Thermopoêle à granulés avec ventilation frontale entièrement désactivable.

Bardage en acier peint or majolique, motoréducteur sans balais de série avec brasier et turbulateurs. Le poêle peut être contrôlé par télécommande avec fonction de thermostat d'ambiance ou kit Wi-Fi de série.

### Pellet thermo-stove with front ventilation, which can be deactivated completely.

Painted steel or ceramic cladding, brushless gearmotor supplied as standard with self-cleaning brazier and turbulators. The product can be managed via remote control, equipped with thermostat control function, or Wi-Fi kit (supplied as standard).

### Pellet-Thermoofen mit Frontlüftung, die komplett deaktiviert werden kann.

Verkleidung aus lackiertem Stahl oder Keramik, bürstenloser Getriebemotor, standardmäßig mit selbstreinigender Brennschale und Turbulatoren ausgestattet. Das Produkt kann über eine Fernbedienung gesteuert werden, die mit einer Thermostatkontrollfunktion, oder WiFi-Kit (im Lieferumfang enthalten) ausgestattet ist.



#### MAIOLICA

Bianco / White / Blanc / Weiß  
Nero / Black / Noir / Schwarz  
Bordeaux / Bordeaux / Bordeaux / Bordeaux  
Nocciola / Hazelnut / Noisette / Haselnuss

#### STEEL

Bianco / White / Blanc / Weiß  
Nero / Black / Noir / Schwarz  
Bordeaux / Bordeaux / Bordeaux / Bordeaux  
Bronzo / Bronze / Bronze / Bronze





PELLET

37 kg

WEIGHT

273 kg

ENERGY



D.M. 186

★★★★★

F.VERTE

7★

WI-FI



REMOTE



nobis

# POLYGON

CALDAIE / BOILER / CHAUDIÈRE / KESSEL

Serbatoio pellet 80kg

80kg pellet tank /  
Réservoir à pellets de 80kg /  
80 kg Pellettank

Capacità acqua fino a 85L

Water capacity up to 85L /  
Capacité D'eau jusqu'à 85L /  
Wasserkapazität bis zu 85L



Kit opzionale acqua sanitaria

Optional DHW kit / Kit ESC optionnel /  
Optionales Warmwasser-Kit

Pulizia automatica del fascio tubiero

Tube automatic cleaning / Nettoyage  
automatique des tubes / Automatische  
Rohrreinigung

Doppio compattatore ceneri

Double ash compactor /  
Double compacteur de cendres /  
Doppelter Ascheverdichter

## Green Technology

Nuovo braciere  
New brazier / Nouveau brasier / Neue Kohlenpfanne

NoX = 105 mg / Nm<sup>3</sup>  
Dust = 2,9 mg / Nm<sup>3</sup>

## Braciere Green Technology

*Green-tech brazier / Brasier de technologie verte / Kohlenbecken mit grüner Technologie*

Il nuovo sistema di post-combustione ideato per la linea caldaie Polygon permette di avere risultati unici per quanto riguarda le emissioni in atmosfera.

The new post-combustion system specifically designed for Polygon boilers help reduce atmospheric emissions with unparalleled results.

Le nouveau système de post-combustion conçu pour les chaudières Polygon aide à réduire les émissions atmosphériques avec des résultats uniques.

Das neue Nachverbrennungssystem, das speziell für Polygon-Kessel entwickelt wurde, trägt mit beispiellosen Ergebnissen dazu bei, die Emissionen in die Atmosphäre zu reduzieren.

## Capacità acqua 85L

*85L water tank / Capacité d'eau de 85L / 85L Wassertank*

La notevole capacità nel corpo macchina permette di avere sempre a disposizione acqua in temperatura per lo scambio ottimale con l'impianto domestico.

A remarkable water tank to always have a stock of water at the right temperature to optimize heat exchange.

Un grand réservoir d'eau pour toujours avoir un stock d'eau à la température idéale pour optimiser les échanges thermiques.

Ein bemerkenswerter Wassertank, der immer über einen Wasservorrat mit der richtigen Temperatur verfügt, um den Wärmeaustausch zu optimieren.

## Doppia pulizia automatica

*Double automatic cleaning / Double nettoyage automatique / Doppelte automatische Reinigung*

Il doppio compattatore per la cenere di combustione e per la pulizia dei turbolatori riduce al minimo gli interventi di pulizia manuale.

Double compactor for combustion ashes and turbulator cleaning to minimize manual interventions.

Le double compacteur pour les cendres de combustion et le nettoyage des turbulateurs permet de minimiser les interventions de manuel.

Doppelverdichter für Verbrennungssasche und Turbulatorreinigung zur Minimierung manueller Eingriffe.

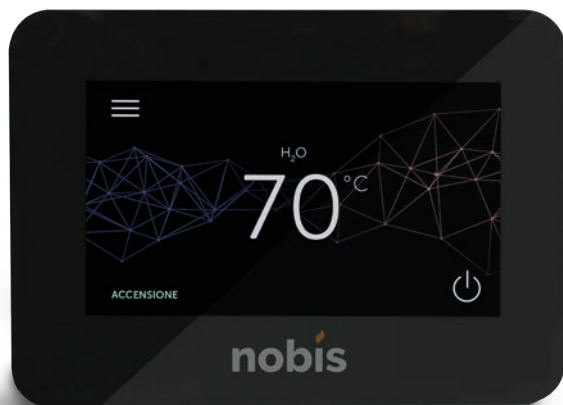

### Nuovo display touchscreen

Display con interfaccia aggiornata, nuovi menu di funzionamento e programmazione degli orari, e procedure guidate per la manutenzione ordinaria e straordinaria.

### New touch display

Display with improved interface, new operating and programming menus, and wizard to assist you in both routine and extraordinary maintenance.

### Nouvel écran tactile

Écran tactile avec interface améliorée, nouveaux menus de fonctionnement et de programmation et procédures guidées pour l'entretien ordinaire et extraordinaire.

### Neues Touch-Display

Display mit verbesserter Benutzeroberfläche, neuen Bedien- und Programmiermenüs und einem Assistenten, der Sie bei routinemäßigen und außerordentlichen Wartungsarbeiten unterstützt.

POT. 7,9 - 26,9 kW

7,2 - 24,7 kW

# POLYGON 25

140  
105

## Caldia a pellet 5 stelle, con braciere autopulente green technology e doppio compattatore ceneri.

Polygon 25 è la caldaia a pellet a cinque stelle con capacità di 85 litri di acqua nel corpo macchina, braciere con nuovo sistema di post-combustione e display touchscreen integrato. Pulizia automatica del fascio tubiero e kit opzionale per l'acqua sanitaria.

## Chaudière à granulés 5 étoiles avec brasier autonettoyant green-tech et double compacteur de cendres.

Polygon 25 est une chaudière à granulés cinq étoiles équipée d'un réservoir d'eau de 85 litres, brasier de dernière génération avec système de post-combustion et écran tactile intégré, système de nettoyage automatique du faisceau de tubes et kit ECS optionnel.

## 5-star pellet boiler with green-tech self-cleaning brazier and double ash compactor.

Polygon 25 is a five-star pellet boiler equipped with an 85l water tank, latest-generation brazier with post-combustion system and integrated touch display, tube-bundle automatic cleaning system and DHW optional kit.

## 5-Sterne-Pelletkessel mit selbstreinigender Green-Tech-Brennschale und doppeltem Ascheverdichter.

Polygon 25 ist ein Fünf-Sterne-Pelletkessel, der mit einem 85-l-Wassertank, einer Brennschale der neuesten Generation mit Nachverbrennungssystem und integriertem Touch-Display, einem automatischen Rohrbündel-Reinigungssystem und einem optionalen Warmwasser-Set ausgestattet ist.



AUTOMATIC  
CLEANING



PELLET  
OPTIMIZER



NOBIS SAFETY  
STANDARD



ECODESIGN  
2022



Versione con serbatoio  
maggiorato da 125 kg

Enlarged tank version 125 kg

Réservoir élargi jusqu'à 125 kg

Vergrößerte Tankversion 125 kg

1280 x 1400 x 620 mm

PELLET

75 kg

WEIGHT

350 kg

ENERGY

A+

D.M. 186

★★★★★

WI-FI





POT. 7,9 - 29,3 kW

7,2 - 27 kW

# POLYGON 28

140  
105

## Caldia a pellet 5 stelle, con braciere autopulente green technology e doppio compattatore ceneri.

Polygon 28 è la caldaia a pellet a cinque stelle con capacità di 85 litri di acqua nel corpo macchina, braciere con nuovo sistema di post-combustione e display touchscreen integrato. Pulizia automatica del fascio tubiero e kit opzionale per l'acqua sanitaria.

## Chaudière à granulés 5 étoiles avec brasier autonettoyant green-tech et double compacteur de cendres.

Polygon 28 est une chaudière à granulés cinq étoiles équipée d'un réservoir d'eau de 85 litres, brasier de dernière génération avec système de post-combustion et écran tactile intégré, système de nettoyage automatique du faisceau de tubes et kit ECS optionnel.

## 5-star pellet boiler with green-tech self-cleaning brazier and double ash compactor.

Polygon 28 is a five-star pellet boiler equipped with an 85l water tank, latest-generation brazier with post-combustion system and integrated touch display, tube-bundle automatic cleaning system and DHW optional kit.

## 5-Sterne-Pelletkessel mit selbstreinigender Green-Tech-Brennschale und doppeltem Ascheverdichter.

Polygon 28 ist ein Fünf-Sterne-Pelletkessel, der mit einem 85-l-Wassertank, einer Brennschale der neuesten Generation mit Nachverbrennungssystem und integriertem Touch-Display, einem automatischen Rohrbündel-Reinigungssystem und einem optionalen Warmwasser-Set ausgestattet ist.



AUTOMATIC  
CLEANING



PELLET  
OPTIMIZER



NOBIS SAFETY  
STANDARD



ECODESIGN  
2022



Versione con serbatoio  
maggiorato da 125 kg

Enlarged tank version 125 kg

Réservoir élargi jusqu'à 125 kg

Vergrößerte Tankversion 125 kg

1280 x 1400 x 620 mm

PELLET

75 kg

WEIGHT

350 kg

ENERGY

A+

D.M. 186

★★★★★

WI-FI



POT. 7,9 - 31,5 kW

7,2 - 29 kW

# POLYGON 32

140  
105

## Caldia a pellet 5 stelle, con braciere autopulente green technology e doppio compattatore ceneri.

Polygon 32 è la caldaia a pellet a cinque stelle con capacità di 85 litri di acqua nel corpo macchina, braciere con nuovo sistema di post-combustione e display touchscreen integrato. Pulizia automatica del fascio tubiero e kit opzionale per l'acqua sanitaria.

## Chaudière à granulés 5 étoiles avec brasier autonettoyant green-tech et double compacteur de cendres.

Polygon 32 est une chaudière à granulés cinq étoiles équipée d'un réservoir d'eau de 85 litres, brasier de dernière génération avec système de post-combustion et écran tactile intégré, système de nettoyage automatique du faisceau de tubes et kit ECS optionnel.

## 5-star pellet boiler with green-tech self-cleaning brazier and double ash compactor.

Polygon 32 is a five-star pellet boiler equipped with an 85l water tank, latest-generation brazier with post-combustion system and integrated touch display, tube-bundle automatic cleaning system and DHW optional kit.

## 5-Sterne-Pelletkessel mit selbstreinigender Green-Tech-Brennschale und doppeltem Ascheverdichter.

Polygon 32 ist ein Fünf-Sterne-Pelletkessel, der mit einem 85-l-Wassertank, einer Brennschale der neuesten Generation mit Nachverbrennungssystem und integriertem Touch-Display, einem automatischen Rohrbündel-Reinigungssystem und einem optionalen Warmwasserbereitungssatz ausgestattet ist.



AUTOMATIC  
CLEANING



PELLET  
OPTIMIZER



NOBIS SAFETY  
STANDARD



ECODESIGN  
2022



Versione con serbatoio  
maggiorato da 125 kg

Enlarged tank version 125 kg

Réservoir élargi jusqu'à 125 kg

Vergrößerte Tankversion 125 kg

1280 x 1400 x 620 mm

PELLET

125 kg

WEIGHT

350 kg

ENERGY

A+

D.M. 186

★★★★★

WI-FI



nobis

# simply MAGIC

## C'è magia nel fuoco

Il profumo del ceppo, il crepitio del fuoco, il fascino incantatore della fiamma che si muove, la sensazione avvolgente e romantica del calore della brace, degli ambienti di una volta, quelli della nostra infanzia.

Tutto questo è la magia della fiamma a legna, del calore secondo la tradizione, del ritorno al passato per ridestare le nostre radici e prendersi il tempo di una piacevole pausa.

La nuova gamma a legna Nobis è pensata per amplificare la magia del fuoco a legna, alla camera di combustione in refrattario alta densità, in grado di ospitare ceppi fino a una lunghezza di 35cm per una fiamma profonda e naturale.

La gestione personalizzata dell'aria primaria e secondaria consente una combustione ottimale per avere una fiamma luminosa e limpida.

La nuova gamma a legna è declinata in stufe con estetica e rivestimenti personalizzabili, e si arricchisce di accessori componibili su tutti i modelli: il cassetto portalegna, il forno e l'accumulo di 75 Kg a lento rilascio, per prolungare il tepore della stufa fino a diverse ore dopo il suo spegnimento.

## The magic of fire

Let yourself be carried away to the memories of yesteryear, and lose yourself in the scent of the logs, the crackling of the fire, the spellbinding charm of the dancing flame, the enveloping, romantic warmth of the embers.

The magic of firewood: travel back through time to rediscover our roots and let yourself sink into moments of pure relaxation. Our new wood-burning stoves, equipped with a high-density refractory combustion chamber, are designed to enhance the magic of a wood fire and can contain logs up to 35 cm in length, for an even more intense and natural-looking flame.

Optimize combustion by adjusting both primary and secondary air and get a bright, vivid flame. All the stoves in the range have customizable coverings and aesthetic features. Moreover, they are made available with modular accessories: from firewood drawer and oven, up to the refractory heat-storage system (75 kg) to keep on releasing heat even several hours after the stove is turned off.

## La magie du feu

L'odeur des bûches, le crépitement du feu, le charme envoûtant de la flamme en mouvement, la sensation enveloppante et romantique de la chaleur des braises, des jours anciens : ceux de notre enfance.

Tout cela, c'est la magie du feu de bois, de la chaleur selon la tradition, du retour au passé pour réveiller nos racines et prendre le temps d'une pause agréable.

La nouvelle gamme Nobis est conçue pour amplifier la magie du feu de bois et dispose d'une chambre de combustion réfractaire à haute densité qui peut accueillir des bûches jusqu'à 35 cm de long pour une flamme encore plus profonde et naturelle. La gestion personnalisée de l'air primaire et secondaire permet une combustion optimale pour une flamme claire et brillante.

La nouvelle gamme de poêles à bois se décline en poêles à l'esthétique et au revêtement personnalisables et s'enrichit d'accessoires modulaires sur tous les modèles : tiroir à bois, four et accumulateur réfractaire de 75 kg pour prolonger la chaleur du poêle jusqu'à plusieurs heures après son extinction.

## Die Magie des Feuers

Lassen Sie sich in die Erinnerungen an vergangene Zeiten entführen und verlieren Sie sich im Duft der Holzscheite, dem Knistern des Feuers, dem bezaubernden Charme der tanzenden Flamme, der umhüllenden, romantischen Wärme der Glut.

Die Magie des Brennholzes: Reisen Sie durch die Zeit, um unsere Wurzeln wiederzuentdecken und sich in Momente purer Entspannung zu versenken.

Unsere neuen Holzöfen sind mit einer Brennkammer aus feuerfestem Material mit hoher Dichte ausgestattet, um den Zauber eines Holzfeuers zu verstärken. Sie können Holzscheite mit einer Länge von bis zu 35 cm aufnehmen und sorgen so für ein noch intensiveres und natürlicheres Flammenbild.

Optimieren Sie die Verbrennung durch die Regulierung der Primär- und Sekundärluft und erhalten Sie eine helle, lebendige Flamme.

Alle Öfen der Serie verfügen über anpassbare Verkleidungen und ästhetische Merkmale. Darüber hinaus sind sie mit modularem Zubehör erhältlich: von der Brennholzschublade über den Ofen bis hin zum feuerfesten Wärmespeichersystem (75 kg), das auch mehrere Stunden nach dem Ausschalten des Ofens noch Wärme abgibt.

## La gamma legna

La gamma a legna Nobis è composta da differenti famiglie di prodotti:

### Flat, Zenith e Classic

Le stufe a legna con estetiche adatte agli ambienti contemporanei, moderni e classici, configurabili con diversi accessori.

### Efrem, Efrem Fly e Efrem Classic

La famiglia di inserti a legna a profondità ridotta, a partire da 38 centimetri. Disponibili in diverse dimensioni e altezze.

### Olga e Lina

Le cucine a legna Nobis, disponibili in diverse finiture e colori, coniugano la concretezza del calore sostenibile al gusto della cucina tradizionale.



## The wood range

Our range of wood-burning stoves is made up of different product families:

### Flat, Zenith and Classic

Wood-burning stoves with aesthetics suitable for contemporary, modern, and classic environments, customizable with different accessories.

### Efrem, Efrem Fly and Efrem Classic

Our line of wood-burning inserts with reduced depth, starting from 38 cm. Available in different sizes.

### Olga e Lina

Our wood-burning cookers, available in different finishes and colours, combine the concreteness of sustainable heat with the taste of traditional cookers.



## La gamme bois

Notre gamme de poêles à bois est composée de différentes familles de produits:

### Flat, Zenith et Classic

Poêles à bois à l'esthétique adaptée aux environnements contemporains, modernes et classiques, personnalisables avec différents accessoires.

### Efrem, Efrem Fly et Efrem Classic

Notre gamme d'inserts à bois à profondeur réduite, à partir de 38 cm. Disponible en différentes tailles.

### Olga et Lina

Nos cuisinières à bois, disponibles en différentes finitions et couleurs, allient le côté concret de la chaleur durable avec le goût des cuisinières traditionnelles.



## Das Holzsortiment

Das Holzfeuerungs-sortiment von Nobis besteht aus verschiedenen Produktfamilien:

### Flat, Zenith und Classic

Holzöfen mit Ästhetik, geeignet für zeitgenössische, moderne und klassische Umgebungen, konfigurierbar mit verschiedenen Zubehörteilen.

### Efrem, Efrem Fly und Efrem Classic

Die Familie der holzbefeuerten Einsätze mit reduzierter Tiefe ab 38 Zentimetern. Erhältlich in verschiedenen Größen und Höhen.

### Olga und Lina

Die Holzöfen von Nobis sind in verschiedenen Ausführungen und Farben erhältlich und vereinen die Konkretheit nachhaltiger Wärme mit dem Geschmack traditioneller Küche.



# nobis



Ventilazione opzionale

*Optional ventilation / Ventilation (en option)  
/ Optionale Belüftung*

Aria secondaria

*Secondary air outlet / Sortie d'air secondaire  
/ Sekundärluftauslass*

Aria primaria

*Primary air outlet / Sortie d'air  
primaire / Primärluftauslass*



Aria terziaria

*Tertiary air outlet / Sortie d'air tertiaire /  
Tertiärer Luftauslass*

Uscita canalizzazione opzionale

*Optional canalization outlet /  
Sortie pour la canalisation (en option) /  
Optionaler Kanalisationsauslass*



Grazie all'impegno nello sviluppo di un prodotto con performance ambientali alte e consumi ridotti, le stufe a legna Nobis sono certificate 5 stelle secondo il D.M. Ambiente 186 del 2006.

Con questa certificazione, le stufe permettono di accedere agli incentivi e detrazioni fiscali previsti dalle normative nazionali e regionali in vigore:

**Bonus 50% Ristrutturazione edilizia**  
**Bonus 50% Riqualificazione energetica**  
**Superbonus**  
**Conto Termico 2.0**  
**Incentivi e detrazioni previste dalle singole regioni.**



flamme  
VERTE

Le label  
du chauffage  
au bois

Le stufe a legna Nobis soddisfano i criteri della certificazione francese Flamme Verte 7 stelle.

Our wood stoves meet the criteria of the French Flamme Verte 7-star certification.

Les poêles à bois Nobis répondent aux critères de la certification française Flamme Verte 7 étoiles.

Unsere Holzöfen erfüllen die Kriterien der französischen Flamme Verte 7-Sterne-Zertifizierung.

Vetro a cornice ridotta  
per visione della fiamma  
ancora più ampia

*Reduced bezel glass for  
even wider view of the flame*

*Verre à cadre réduit pour  
une vue dégagée de la flamme*

*Reduzierter Glasrahmen für  
noch breitere Sicht auf die Flamme*



45<sub>CM</sub>

32<sub>CM</sub>

35<sub>CM</sub>



## Più spazio per il tuo calore

Le stufe a legna Nobis sono dotate di una camera di combustioni ampia, che misura 32 x 35 x 45 cm e consente l'utilizzo di ceppi fino a 35 cm di lunghezza.

Il vetro a cornice ridotta permette una visione completa, per vivere l'esperienza di una fiamma ancora più corposa e luminosa.

La camera di combustione è realizzata in vermiculite ad alta densità e permette di raggiungere performance ambientali tra le migliori disponibili sul mercato, con basse emissioni e alti rendimenti.

## Plus d'espace pour votre chaleur

Les poêles à bois Nobis possèdent une grande chambre de combustion, qui mesure 32 x 35 x 45 cm et permettent d'utiliser bûches d'une longueur maximale de 35 cm.

Le cadre de la vitre d'épaisseur réduite permet de profiter d'une vue complète de la flamme, afin que vous puissiez jouir d'une flamme encore plus pleine et brillante.

La chambre de combustion est constituée de vermiculite à haute densité et atteint des performances environnementales parmi les meilleures disponibles sur le marché, avec faibles émissions et rendement élevé.

## Make some room for your warmth

Our wood-burning stoves are equipped with a large combustion chamber (32 x 35 x 45 cm) which can contain logs up to 35 cm in length.

The small-framed glass offers a perfect view of the interior to enjoy the flame to the full.

The highly-efficient, low-emission combustion chamber is made of high-density vermiculite and has allows to achieve one of the best environmental performance available on the market.

## Schaffen Sie Platz für Ihre Wärme

Unsere Holzöfen sind mit einer großen Brennkammer (32 x 35 x 45 cm) ausgestattet, die Holzsplitte mit einer Länge von bis zu 35 cm aufnehmen kann.

Das Kleingerahmte Glas bietet eine perfekte Sicht auf den Innenraum, um das Flammenspiel in vollen

Zügen genießen zu können. Die hocheffiziente, emissionsarme Brennkammer besteht aus hochdichtem Vermiculit und ermöglicht eine der besten Umweltleistungen, die auf dem Markt erhältlich sind.



## Nuovi accessori, componibili

New,  
modular  
accessories

Nouveaux  
accessoires  
modulaires

Neues,  
modulares  
Zubehör

### Scegli la base

Choose the base / Choisissez la base / Wählen Sie die Basis



#### Cassetto porta attrezzi

*Tool drawer / Tiroir à outils / Werkzeugschublade*

Un comodo cassetto porta attrezzi con rivestimento coordinato alla stufa.

A convenient tool drawer with matching coating.

Un tiroir pratique avec un revêtement assorti.

Eine praktische Werkzeugschublade mit passender Beschichtung.



#### Portalegna aperto

*Open log holder / Porte-bûches ouvert / Holzhalter öffnen*

Un pratico scomparto portalegna per ordinare i ceppi e dare alla casa un tocco di tradizione.

A handy log storage compartment to give your home a traditional feel.

Un compartiment pratique pour le stockage des bûches et pour donner à votre maison une touche traditionnelle.

Ein praktisches Holzlagerfach, das Ihrem Zuhause ein traditionelles Flair verleiht.

Accumulo e rilascio del calore nel tempo in una stufa con accumulatore in refrattario e senza.

Heat storage and release over time in a stove with a refractory accumulator and without.

Stockage et libération de la chaleur dans le temps dans un poêle avec et sans accumulateur réfractaire.

Wärmespeicherung und -abgabe über die Zeit in einem Ofen mit und ohne feuerfesten Akkumulator.

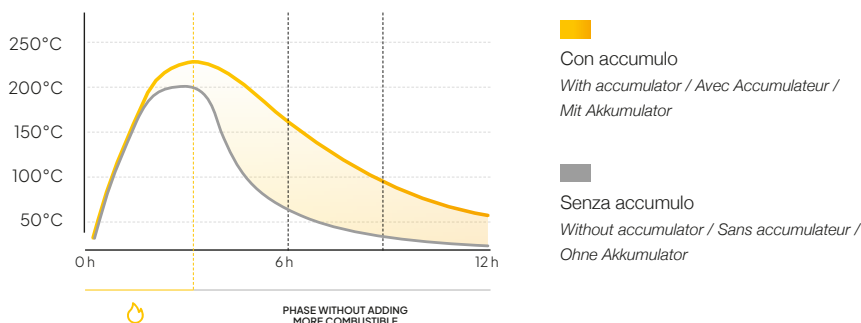

## Scegli il top

Choose the top / Choisissez le panneau supérieur / Wählen Sie die Oberseite



### Forno

Oven / Four / Ofen

È possibile installare nella parte superiore un pratico forno, un metodo di cottura tradizionale che esalta i profumi e i sapori della cucina italiana.

A practical oven can be installed at the top of the stove to cook your favorite dishes in the traditional way and enhance the flavor and aroma of your favorite recipes.

Un four pratique peut être installé dans la partie supérieure du poêle pour cuisiner vos plats préférés de manière traditionnelle et rehausser la saveur et l'arôme de vos recettes préférées.

Oben am Herd kann ein praktischer Ofen installiert werden, um Ihre Lieblingsgerichte auf traditionelle Weise zuzubereiten und den Geschmack und das Aroma Ihrer Lieblingsrezepte zu verbessern.

### Accumulo in refrattario

Refractory accumulator / Accumulateur réfractaire / Feuerfester Akkumulator

L'accumulo supplementare da 75Kg in refrattario può accumulare il calore quando la stufa è accesa, per rilasciarlo nelle ore successive allo spegnimento, mantenendo l'ambiente tiepido anche dopo diverse ore.

An additional 75 Kg heat accumulator can store the heat generated during operation, and release it after the stove is turned off, keeping the room warm even after several hours.

L'accumulateur réfractaire supplémentaire de 75 kg peut emmagasiner de la chaleur lorsque le poêle est allumé et la restituer dans les heures qui suivent son arrêt, ce qui permet de garder la pièce chaude même après plusieurs heures.

Ein zusätzlicher 75 kg schwerer Wärmespeicher kann die beim Betrieb entstehende Wärme speichern und nach dem Ausschalten des Ofens wieder abgeben, so dass der Raum auch nach mehreren Stunden noch warm bleibt.

# EFREM CLASSIC 700 .49

# EFREM CLASSIC 800 .55

EFREM 700.49

EFREM 800.55

49  
67

55  
76

**Stufa a legna cinque stelle a profondità ridotta di soli 40cm, con camera di combustione in ceramica refrattaria.**

Stufa a legna a convezione naturale di dimensioni compatte, controllo dell'aria primaria e secondaria con presa d'aria posteriore o inferiore. Fondo a letto di brace, porta in vetro con cornice ridotta per un'ampia visione della fiamma.

**Poêle à bois 7 étoiles d'une profondeur réduite de seulement 40 cm, équipé d'une chambre de combustion en céramique réfractaire.**

Taille compacte, convection naturelle, contrôle de l'air primaire et secondaire avec prise d'air arrière ou inférieure. Les braises tombent directement sur le fond (pas de tiroir à cendres), porte vitrée avec cadre réduit pour une meilleure vue sur la flamme.

**Wood-burning stove with a reduced depth of just 40 cm, equipped with refractory ceramic combustion chamber.**

Compact size, natural convection, primary and secondary air control with rear or bottom air intake. The embers fall directly onto the bottom (no ash drawer), glass door with reduced frame for a greater view of the flame.

**Holzofen mit einer reduzierten Tiefe von nur 40 cm und einer feuerfesten Keramikbrennkammer.**

Kompakter Holzofen mit natürlicher Konvektion, Primär- und Sekundärluftregelung mit Lufteinlass hinten oder unten. Boden ohne Ascheschublade, Glastür mit reduziertem Rahmen für einen weiten Blick auf die Flamme.



CLEAN-GLASS SYSTEM



HERMETIC CONSTRUCTION



NOBIS SAFETY STANDARD



ECODESIGN 2022





WOOD

-

WEIGHT

80 kg

ENERGY

A+

D.M. 186

★★★★★

F.VERTE

7★

CANAL.

POT. 8,5 kW | 10,2 kW

8 | 10

# FLAT 100

79  
51  $\frac{1}{45}$

**Stufa a legna 5 stelle a convezione naturale con camera di combustione in vermiculite alta densità per ceppi fino a 35cm.**

Rivestimento in acciaio verniciato, controllo dell'aria primaria, secondaria e terziaria. Vetro a cornice ridotta per una visione della fiamma ancora più ampia.

**Poêle à bois 7 étoiles à convection naturelle, avec chambre de combustion en vermiculite à haute densité pour bûches jusqu'à 35 cm.**

Revêtement en acier peint, contrôle de l'air primaire, secondaire et tertiaire. Vitre à cadre réduit pour une vue dégagée de la flamme.

**Natural-convection wood stove equipped with high-density vermiculite combustion chamber for logs up to 35 cm.**

Painted steel coating. Primary, secondary and tertiary air control. Thinner glass frame for greater view of the flame.

**Holzofen mit natürlicher Konvektion, ausgestattet mit einer hochdichten Vermiculit-Brennkammer für Holzscheite bis zu 35 cm.**

Lackierte Stahlbeschichtung. Primär-, Sekundär- und Tertiärluftregelung. Dünnerer Glasrahmen für bessere Sicht auf die Flamme.



CLEAN-GLASS SYSTEM



HERMETIC CONSTRUCTION



NOBIS SAFETY STANDARD



ECODESIGN 2022





WOOD

35 cm

WEIGHT

145 kg

ENERGY

A+

D.M. 186

★★★★★

F.VERTE

7★

CANAL.

POT. 8,5 kW | 10,2 kW

8 | 10

# FLAT 300 FLAT 330



**Standard**  
Standard  
Standard  
Standard

**Con forno**  
With oven  
Avec four  
Mit Backofen

**Con accumulatore**  
With accumulator  
Avec accumulateur  
Mit Akkumulator



**Stufa a legna 5 stelle a convezione naturale, ventilazione opzionale o canalizzazione singola posteriore opzionale.**

Rivestimento in acciaio verniciato, camera di combustione in vermiculite alta densità per ceppi fino a 35cm di lunghezza, controllo dell'aria primaria, secondaria e terziaria. Vetro a cornice ridotta per una visione della fiamma ancora più ampia

**Natural-convection wood stove, ventilation system (optional), or single rear canalization (optional).**

Painted steel coating, high-density vermiculite combustion chamber for logs long up to 35 cm. Primary, secondary and tertiary air control. Thinner glass frame for greater view of the flame.

**Poêle à bois 7 étoiles avec convection naturelle, ventilation (en option) ou canalisation arrière simple (en option).**

Revêtement en acier peint, chambre de combustion en vermiculite à haute densité pour des bûches jusqu'à 35 cm de long, contrôle de l'air primaire, secondaire et tertiaire. Vitre à cadre réduit pour une vision encore plus large de la flamme.

**Holzofen mit natürlicher Konvektion, Belüftungssystem (optional) oder einzelne hintere Kanalisation (optional).**

Lackierte Stahlbeschichtung, hochdichte Vermiculit-Brennkammer für Holzscheite mit einer Länge von bis zu 35 cm. Primär-, Sekundär- und Tertiärluftregelung. Dünnerer Glasrahmen für bessere Sicht auf die Flamme.



CLEAN-GLASS SYSTEM



HERMETIC CONSTRUCTION



NOBIS SAFETY STANDARD



ECODESIGN 2022



Bianco  
White  
Blanc  
Weiß

Nero  
Black  
Noir  
Schwarz

Bronzo  
Bronze  
Bronze  
Bronze

Bianco  
White  
Blanc  
Weiß

Nero  
Black  
Noir  
Schwarz

Bronzo  
Bronze  
Bronze  
Bronze





WOOD

35 cm

WEIGHT

165 kg

ENERGY

A+

D.M. 186

★★★★★

F.VERTE

7★

CANAL.



Single  
optional



POT. 8,5 kW | 10,2 kW

8 | 10

# FLAT 500 FLAT 550



**Standard**  
Standard  
Standard  
Standard

**Con forno**  
With oven  
Avec four  
Mit Backofen

**Con accumulatore**  
With accumulator  
Avec accumulateur  
Mit Akkumulator



**Stufa a legna a convezione naturale, ventilazione opzionale o canalizzazione singola posteriore opzionale.**

Rivestimento in pietra, camera di combustione in vermiculite alta densità per ceppi fino a 35cm di lunghezza, controllo dell'aria primaria, secondaria e terziaria. Vetro a cornice ridotta per una visione della fiamma ancora più ampia.

**Natural-convection wood stove, ventilation system (optional), or single rear canalization (optional).**

Stone coating, high-density vermiculite combustion chamber for logs long up to 35 cm. Primary, secondary and tertiary air control. Thinner glass frame for greater view of the flame.

**Poêle à bois 7 étoiles avec convection naturelle, ventilation (en option) ou canalisation arrière simple (en option).**

Revêtement en pierre, chambre de combustion en vermiculite à haute densité pour des bûches jusqu'à 35 cm de long, contrôle de l'air primaire, secondaire et tertiaire. Vitre à cadre réduit pour une vision encore plus large de la flamme.

**Holzofen mit natürlicher Konvektion, Belüftungssystem (optional) oder einzelne hintere Kanalisation (optional).**

Steinbeschichtung, hochdichte Vermiculit-Brennkammer für Holzstücke mit einer Länge von bis zu 35 cm. Primär-, Sekundär- und Tertiärluftregelung. Dünnerer Glasrahmen für bessere Sicht auf die Flamme.



CLEAN-GLASS SYSTEM



HERMETIC CONSTRUCTION



NOBIS SAFETY STANDARD



ECODESIGN 2022



Grey

Dark

Travertino

Grey

Dark

Travertino

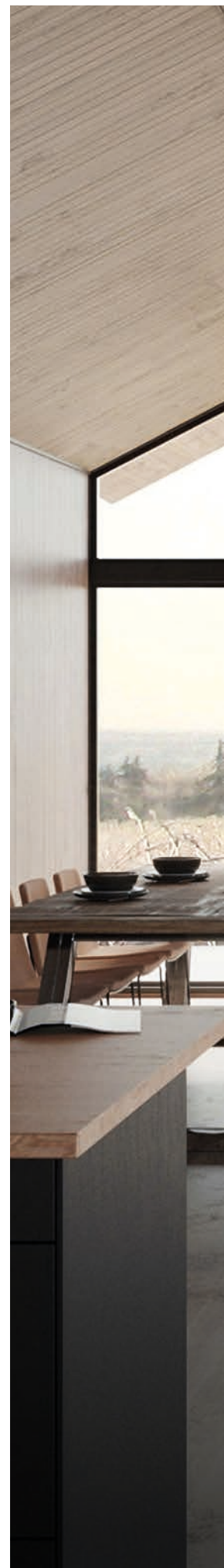



WOOD

35 cm

WEIGHT

165 kg

ENERGY

A+

D.M. 186

★★★★★

F.VERTE

7★

CANAL.



Single  
optional

POT. 8,5 kW | 10,2 kW

8 | 10

# FLAT 700 FLAT 770



**Standard**  
Standard  
Standard  
Standard

**Con forno**  
With oven  
Avec four  
Mit Backofen

**Con accumulatore**  
With accumulator  
Avec accumulateur  
Mit Akkumulator

120  
48  
45

**Stufa a legna 5 stelle a convezione naturale, ventilazione opzionale o canalizzazione singola posteriore opzionale.**

Rivestimento in pietra, camera di combustione in vermiculite alta densità per ceppi fino a 35cm di lunghezza, controllo dell'aria primaria, secondaria e terziaria. Vetro a cornice ridotta per una visione della fiamma ancora più ampia.

**Natural-convection wood stove, ventilation system (optional), or single rear canalization (optional).**

Stone coating, high-density vermiculite combustion chamber for logs long up to 35 cm. Primary, secondary and tertiary air control. Thinner glass frame for greater view of the flame.

**Poêle à bois 7 étoiles avec convection naturelle, ventilation (en option) ou canalisation arrière simple (en option).**

Revêtement en pierre, chambre de combustion en vermiculite à haute densité pour des bûches jusqu'à 35 cm de long, contrôle de l'air primaire, secondaire et tertiaire. Vitre à cadre réduit pour une vision encore plus large de la flamme.

**Holzofen mit natürlicher Konvektion, Belüftungssystem (optional) oder einzelne hintere Kanalisation (optional).**

Steinbeschichtung, hochdichte Vermiculit-Brennkammer für Holzscheite mit einer Länge von bis zu 35 cm. Primär-, Sekundär- und Tertiärluftregelung. Dünnerer Glasrahmen für bessere Sicht auf die Flamme.



CLEAN-GLASS SYSTEM



HERMETIC CONSTRUCTION



NOBIS SAFETY STANDARD



ECODESIGN 2022



Grey

Dark

Travertino

Grey

Dark

Travertino





WOOD

35 cm

WEIGHT

165 kg

ENERGY



D.M. 186

★★★★★

F.VERTE

7★

CANAL.



Single  
optional

POT. 8,5 kW | 10,2 kW

8 | 10

# ZENITH 400 ZENITH 440



**Standard**  
Standard  
Standard  
Standard

**Con forno**  
With oven  
Avec four  
Mit Backofen

**Con accumulatore**  
With accumulator  
Avec accumulateur  
Mit Akkumulator

120  
53  
AB

**Stufa a legna a convezione naturale, ventilazione opzionale o canalizzazione singola posteriore opzionale.**

Rivestimento in maiolica colorata, camera di combustione in vermiculite alta densità per ceppi fino a 35cm di lunghezza, controllo dell'aria primaria, secondaria e terziaria. Vetro a cornice ridotta per una visione della fiamma ancora più ampia

**Natural-convection wood stove, ventilation system (optional), or single rear canalization (optional).**

Colored majolica cladding, high-density vermiculite combustion chamber for logs long up to 35 cm. Primary, secondary and tertiary air control. Thinner glass frame for greater view of the flame.

**Poêle à bois 7 étoiles avec convection naturelle, ventilation (en option) ou canalisation arrière simple (en option).**

Revêtement en majolique colorée, chambre de combustion en vermiculite à haute densité pour des bûches jusqu'à 35 cm de long, contrôle de l'air primaire, secondaire et tertiaire. Vitre à cadre réduit pour une vision encore plus large de la flamme.

**Holzofen mit natürlicher Konvektion, Belüftungssystem (optional) oder einzelne hintere Kanalisation (optional).**

Farbige Majolika-Verkleidung, hochdichte Vermiculit-Brennkammer für Holzscheite mit einer Länge von bis zu 35 cm. Primär-, Sekundär- und Tertiärluftregelung. Dünnerer Glasrahmen für bessere Sicht auf die Flamme.



CLEAN-GLASS SYSTEM



HERMETIC CONSTRUCTION



NOBIS SAFETY STANDARD



ECODESIGN 2022



Bianco  
White  
Blanc  
Weiß

Grigio  
Grey  
Gris  
Grau

Bordeaux  
Bordeaux  
Bordeaux  
Bordeaux

Bianco  
White  
Blanc  
Weiß

Grigio  
Grey  
Gris  
Grau

Bronzo  
Bronze  
Bronze  
Bronze



WOOD

35 cm

WEIGHT

165 kg

ENERGY

A+

D.M. 186

★★★★★

F.VERTE

7★

CANAL.



Single  
optional

POT. 8,5 kW | 10,2 kW

8 | 10

# ZENITH 600 ZENITH 660



**Standard**  
Standard  
Standard  
Standard

**Con forno**  
With oven  
Avec four  
Mit Backofen

**Con accumulatore**  
With accumulator  
Avec accumulateur  
Mit Akkumulator



**Stufa a legna 5 stelle a convezione naturale, ventilazione opzionale o canalizzazione singola posteriore opzionale.**

Rivestimento in acciaio verniciato, camera di combustione in vermiculite alta densità per ceppi fino a 35cm di lunghezza, controllo dell'aria primaria, secondaria e terziaria. Vetro a cornice ridotta per una visione della fiamma ancora più ampia

**Natural-convection wood stove, ventilation system (optional), or single rear canalization (optional).**

Painted steel coating, high-density vermiculite combustion chamber for logs long up to 35 cm. Primary, secondary and tertiary air control. Thinner glass frame for greater view of the flame.

**Poêle à bois 7 étoiles avec convection naturelle, ventilation (en option) ou canalisation arrière simple (en option).**

Revêtement en acier peint, chambre de combustion en vermiculite à haute densité pour des bûches jusqu'à 35 cm de long, contrôle de l'air primaire, secondaire et tertiaire. Vitre à cadre réduit pour une vision encore plus large de la flamme.

**Holzofen mit natürlicher Konvektion, Belüftungssystem (optional) oder einzelne hintere Kanalisation (optional).**

Lackierte Stahlbeschichtung, hochdichte Vermiculit-Brennkammer für Holzscheite mit einer Länge von bis zu 35 cm. Primär-, Sekundär- und Tertiärluftregelung. Dünnerer Glasrahmen für bessere Sicht auf die Flamme.



CLEAN-GLASS SYSTEM



HERMETIC CONSTRUCTION



NOBIS SAFETY STANDARD



ECODESIGN 2022



Bianco  
White  
Blanc  
Weiß

Nero  
Black  
Noir  
Schwarz

Bronzo  
Bronze  
Bronze  
Bronze

Bianco  
White  
Blanc  
Weiß

Nero  
Black  
Noir  
Schwarz

Bronzo  
Bronze  
Bronze  
Bronze

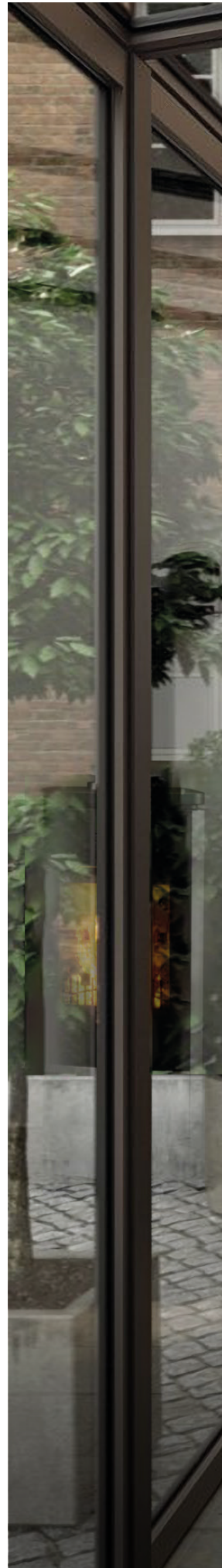



WOOD

35 cm

WEIGHT

165 kg

ENERGY

A+

D.M. 186

★★★★★

F.VERTE

7★

CANAL.



Single  
optional



POT. 8,5 kW | 10,2 kW

8 | 10

# ZENITH 800 ZENITH 880



**Standard**  
Standard  
Standard  
Standard

**Con forno**  
With oven  
Avec four  
Mit Backofen

**Con accumulatore**  
With accumulator  
Avec accumulateur  
Mit Akkumulator



**Stufa a legna 5 stelle a convezione naturale, ventilazione opzionale o canalizzazione singola posteriore opzionale.**

Rivestimento in vetro, camera di combustione in vermiculite alta densità per ceppi fino a 35cm di lunghezza, controllo dell'aria primaria, secondaria e terziaria. Vetro a cornice ridotta per una visione della fiamma ancora più ampia

**Natural-convection wood stove, ventilation system (optional), or single rear canalization (optional).**

Glass coating, high-density vermiculite combustion chamber for logs long up to 35 cm. Primary, secondary and tertiary air control. Thinner glass frame for greater view of the flame.

**Poêle à bois 7 étoiles avec convection naturelle, ventilation (en option) ou canalisation arrière simple (en option).**

Revêtement en verre, chambre de combustion en vermiculite à haute densité pour des bûches jusqu'à 35 cm de long, contrôle de l'air primaire, secondaire et tertiaire. Vitre à cadre réduit pour une vision encore plus large de la flamme.

**Holzofen mit natürlicher Konvektion, Belüftungssystem (optional) oder einzelne hintere Kanalisation (optional).**

Glasbeschichtung, hochdichte Vermiculit-Brennkammer für Holzscheite mit einer Länge von bis zu 35 cm. Primär-, Sekundär- und Tertiärluftkontrolle. Dünnerer Glasrahmen für bessere Sicht auf die Flamme.



CLEAN-GLASS SYSTEM



HERMETIC CONSTRUCTION



NOBIS SAFETY STANDARD



ECODESIGN 2022



Carbon look

Black glass

Wengé

Carbon look

Black glass

Wengé

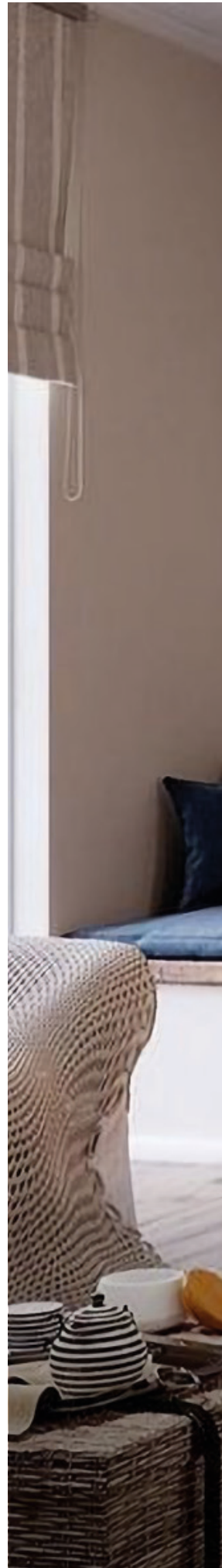



WOOD

35 cm

WEIGHT

165 kg

ENERGY

A+

D.M. 186

★★★★★

F.VERTE

7★

CANAL.



Single  
optional

POT. 8,5 kW | 10,2 kW

8 | 10

# CLASSIC 200 CLASSIC 220



**Standard**  
Standard  
Standard  
Standard

**Con forno**  
With oven  
Avec four  
Mit Backofen

**Con accumulatore**  
With accumulator  
Avec accumulateur  
Mit Akkumulator



**Stufa a legna 5 stelle a convezione naturale, ventilazione opzionale o canalizzazione singola posteriore opzionale.**

Rivestimento in maiolica colorata, camera di combustione in vermiculite alta densità per ceppi fino a 35cm di lunghezza, controllo dell'aria primaria, secondaria e terziaria. Vetro a cornice ridotta per una visione della fiamma ancora più ampia

**Natural-convection wood stove, ventilation system (optional), or single rear canalization (optional).**

Colored majolica cladding, high-density vermiculite combustion chamber for logs long up to 35 cm. Primary, secondary and tertiary air control. Thinner glass frame for greater view of the flame.

**Poêle à bois 7 étoiles avec convection naturelle, ventilation (en option) ou canalisation arrière simple (en option).**

Revêtement en majolique colorée, chambre de combustion en vermiculite à haute densité pour des bûches jusqu'à 35 cm de long, contrôle de l'air primaire, secondaire et tertiaire. Vitre à cadre réduit pour une vision encore plus large de la flamme.

**Holzofen mit natürlicher Konvektion, Belüftungssystem (optional) oder einzelne hintere Kanalisation (optional).**

Farbige Majolika-Verkleidung, hochdichte Vermiculit-Brennkammer für Holzscheite mit einer Länge von bis zu 35 cm. Primär-, Sekundär- und Tertiärluftregelung. Dünnerer Glasrahmen für bessere Sicht auf die Flamme.



CLEAN-GLASS SYSTEM



HERMETIC CONSTRUCTION



NOBIS SAFETY STANDARD



ECODESIGN 2022



Bianco  
White  
Blanc  
Weiß

Bordeaux  
Bordeaux  
Bordeaux  
Bordeaux

Grigio  
Grey  
Gris  
Grau



Bianco  
White  
Blanc  
Weiß

Bordeaux  
Bordeaux  
Bordeaux  
Bordeaux

Grigio  
Grey  
Gris  
Grau





WOOD

35 cm

WEIGHT

165 kg

ENERGY

A+

D.M. 186

★★★★★

F.VERTE

7★

CANAL.



Single  
optional

POT. 10 kW | 10,5 kW\* | 11 kW\*

# EFREM 700.49 / 800.49 / 900.49

EFREM 700.49

EFREM 800.49

EFREM 900.49

49  
66

49  
76

49  
86

**Inserto a legna cinque stelle a profondità ridotta di soli 38cm, con camera di combustione in ceramica refrattaria.**

Inserto a convezione naturale con ventilazione e doppia canalizzazione superiore opzionali, controllo dell'aria primaria e secondaria con presa d'aria posteriore o inferiore. Fondo a letto di brace, porta in vetro con cornice ridotta per un'ampia visione della fiamma.

**Insert à bois d'une profondeur réduite de seulement 38 cm, équipé d'une chambre de combustion en céramique réfractaire.**

Insert à convection naturelle avec ventilation en option et double canalisation supérieure, contrôle de l'air primaire et secondaire avec prise d'air arrière ou inférieure. Les braises tombent directement sur le fond (pas de tiroir à cendres). Porte vitrée avec cadre réduit pour une meilleure vue de la flamme.

**Wood-burning insert with a reduced depth of just 38cm, equipped with refractory ceramic combustion chamber.**

Natural convection insert with optional ventilation and double upper ducting, primary and secondary air control with rear or bottom air intake. The embers fall directly onto the bottom (no ash drawer). Glass door with reduced frame for a greater view of the flame.

**Holz Brenneinsatz mit einer reduzierten Tiefe von nur 38 cm, mit feuerfester Keramikbrennkammer.**

Natürlicher Konvektionseinsatz mit optionaler Belüftung und doppelter oberer Luftführung, Primär- und Sekundärluftregelung mit Lufteinlass hinten oder unten. Boden ohne Ascheschublade, Glastür mit reduziertem Rahmen für einen weiten Blick auf die Flamme.



CLEAN-GLASS SYSTEM



NOBIS SAFETY STANDARD



ECODESIGN 2022

↔ L 66cm

↕ H 49cm

↔ L 76cm

↕ H 49cm

↔ L 86cm

↕ H 49cm





WOOD

-

WEIGHT

80 kg

ENERGY

A+

D.M. 186

★★★★★

F.VERTE

7★

CANAL.



Double  
Optional

POT. 10 kW | 10,5 kW\* | 11 kW\*

# EFREM 700.55 / 800.55 / 900.55

EFREM 700.55

EFREM 800.55

EFREM 900.55



**Inserto a legna cinque stelle a profondità ridotta di soli 38cm, con camera di combustione in ceramica refrattaria.**

Inserto a convezione naturale con ventilazione e doppia canalizzazione superiore opzionali, controllo dell'aria primaria e secondaria con presa d'aria posteriore o inferiore. Fondo a letto di brace, porta in vetro con cornice ridotta per un'ampia visione della fiamma.

**Insert à bois d'une profondeur réduite de seulement 38 cm, équipé d'une chambre de combustion en céramique réfractaire.**

Insert à convection naturelle avec ventilation en option et double canalisation supérieure, contrôle de l'air primaire et secondaire avec prise d'air arrière ou inférieure. Les braises tombent directement sur le fond (pas de tiroir à cendres). Porte vitrée avec cadre réduit pour une meilleure vue de la flamme.

**Wood-burning insert with a reduced depth of just 38cm, equipped with refractory ceramic combustion chamber.**

Natural convection insert with optional ventilation and double upper ducting, primary and secondary air control with rear or bottom air intake. The embers fall directly onto the bottom (no ash drawer). Glass door with reduced frame for a greater view of the flame.

**Holz Brenneinsatz mit einer reduzierten Tiefe von nur 38 cm, mit feuerfester Keramikbrennkammer.**

Natürlicher Konvektionseinsatz mit optionaler Belüftung und doppelter oberer Luftführung, Primär- und Sekundärluftregelung mit Lufteinlass hinten oder unten. Boden ohne Ascheschublade, Glastür mit reduziertem Rahmen für einen weiten Blick auf die Flamme.



CLEAN-GLASS SYSTEM



NOBIS SAFETY STANDARD



ECODESIGN 2022

↔ L 66cm

↕ H 55cm



↔ L 76cm

↕ H 55cm



↔ L 86cm

↕ H 55cm





WOOD

-

WEIGHT

80 kg

ENERGY

A+

D.M. 186

★★★★★

F.VERTE

7★

CANAL.



Double  
Optional



POT. 10 kW | 10,5 kW\*

# EFREM FLY 700 .49

# EFREM FLY 800 .55

EFREM 700.49

EFREM 800.55

49  
67

55  
76

**Inserto a legna cinque stelle a profondità ridotta di soli 40cm, con camera di combustione in ceramica refrattaria.**

Inserto a convezione naturale sospeso, controllo dell'aria primaria e secondaria con presa d'aria posteriore o inferiore. Fondo a letto di brace, porta in vetro con cornice ridotta per un'ampia visione della fiamma.

**Insert à bois avec une profondeur réduite de seulement 40 cm, équipé d'une chambre de combustion en céramique réfractaire.**

Insert suspendu à convection naturelle, régulation d'air primaire et secondaire avec prise d'air arrière ou inférieure. Les braises tombent directement sur le fond (pas de tiroir à cendres). Porte vitrée avec cadre réduit pour une meilleure vue de la flamme.

**Wood-burning insert with a reduced depth of just 40 cm, equipped with refractory ceramic combustion chamber.**

Natural-convection suspended insert, primary and secondary air control with rear or bottom air intake. The embers fall directly onto the bottom (no ash drawer). Glass door with reduced frame for a greater view of the flame.

**Holzbrenneinsatz mit einer reduzierten Tiefe von nur 40 cm, mit feuerfester Keramikbrennkammer.**

Hängender natürlicher Konvektionseinsatz, Primär- und Sekundärluftregelung mit hinterem oder unterem Lufteinlass. Boden ohne Ascheschublade, Glastür mit reduziertem Rahmen für einen weiten Blick auf die Flamme.



CLEAN-GLASS SYSTEM



NOBIS SAFETY STANDARD



ECODESIGN 2022

↔ L 66cm

↑↓ H 49cm

↔ L 76cm

↑↓ H 55cm





WOOD

-

WEIGHT

80 kg

ENERGY

A+

D.M. 186

★★★★★

F.VERTE

7★



# CUCINE

COOKERS / CUISINIÈRES / HERDE

**nobis**



Olga



Lina



Lina gres

## Semplicemente cucina

Le cucine a legna sono il punto di unione tra i moderni metodi di riscaldamento e la tradizione delle stufe classiche, usate per cuocere le pietanze e allo stesso tempo per riscaldare l'ambiente di installazione. Il profumo della legna si coniuga con gli aromi delle cotture sulla piastra radiante e del forno, la gestione separata dell'aria primaria e secondaria ottimizza il rendimento e diminuisce il consumo di legna e le emissioni.

## Simply cookers

Our wood-burning cookers combine modern heating methods with the tradition of classic stoves and are used to cook food and heat the surrounding environment at the same time. The scent of the wood blends with the aroma of the dishes placed to cook on the radiant plate or in the oven. The separate management of primary and secondary air optimizes performance and reduces wood consumption and emissions.

## Tout simplement, cuisinières

Nos cuisinières à bois allient les méthodes de chauffage modernes à la tradition des poêles classiques et permettent en même temps de cuire des aliments et de chauffer l'environnement. Le parfum du bois se mêle à l'arôme des plats placés à cuire sur la plaque radiante ou dans le four. La gestion séparée de l'air primaire et secondaire optimise les performances et réduit la consommation de bois et les émissions.

## Einfach Herd

Holzöfen sind die Verbindung zwischen modernen Heizmethoden und der Tradition klassischer Öfen, die zum Kochen von Speisen und gleichzeitig zum Heizen der Installationsumgebung verwendet werden. Der Duft von Holz verbindet sich mit den Aromen von Gerichten, die auf der Heizplatte und im Ofen zubereitet werden. Die getrennte Führung von Primär- und Sekundärluft optimiert die Leistung und reduziert den Holzverbrauch und die Emissionen.

nobis



# CUCINE



COOKERS / CUISINIÈRES / HERDE

Piano in acciaio levigato con anelli in ghisa

*Steel top with cast-iron rings  
Plateau en acier avec anneaux en fonte  
Stahlplatte mit gusseisernen Ringen*

Camera di combustione profonda 49 cm  
in cemento refrattario

*Refractory 49-cm deep  
combustion chamber  
Chambre de combustion  
en réfractaire de 49 cm  
de profondeur  
49 cm tiefe Feuerfestbeton  
-Brennkammer*

Cassetto cenere estraibile

*Removable ash drawer  
Tiroir à cendres amovible  
Herausnehmbare Ascheschublade*

Ampio scomparto portaoggetti

*Large storage compartment  
Grand compartiment de rangement  
Ein großes Ablagefach*

Uscita fumi superiore

*Upper flue exit pipe  
Conduit de fumée supérieur  
Oberes Rauchabzugsrohr*

Rivestimento interno in refrattario

*Refractory cladding  
Revêtement réfractaire  
Feuerfeste Verkleidungen*

Forno da 40 L in acciaio inox

*40 L stainless steel oven  
Four en acier inoxydable 40 L  
40-Liter-Backofen aus Edelstahl*



## Piastra radiante con anelli in ghisa

*Cast-iron radiant plate / Plaque radiante en fonte / Strahlende Platte*

Gli anelli in ghisa e il ripiano in acciaio inox permettono una distribuzione del calore ideale per la cottura e una pulizia semplice delle superfici.

The cast-iron rings and stainless steel shelf allow ideal heat distribution for cooking and easy cleaning of surfaces.

Les anneaux en fonte et le plateau en acier inoxydable permettent une répartition idéale de la chaleur pour la cuisson et un nettoyage facile des surfaces.

Die gusseisernen Ringe und der Edelstahlboden ermöglichen eine ideale Wärmeverteilung beim Kochen und eine einfache Reinigung der Oberflächen.

## Forno con capacità 40L

*Oven with 40L capacity / Four d'une capacité de 40L / Backofen mit 40L Fassungsvermögen*

Un capiente forno con porta in vetro ceramico e termometro, l'ideale per cuocere o riscaldare mantenendo il controllo della temperatura.

Un grand four avec une porte en verre céramique et un thermomètre, idéal pour cuire ou chauffer tout en maintenant le contrôle de la température.

A large oven with ceramic glass door and thermometer, ideal for baking or heating while maintaining temperature control.

Ein großer Backofen mit Glaskeramiktür und Thermometer, ideal zum Backen oder Heizen bei gleichzeitiger Temperaturkontrolle.

## Camera di combustione profonda

*Deep combustion chamber / Chambre de combustion profonde / Tiefe Brennkammer*

La camera di combustione profonda 49 centimetri in cemento refrattario permette un caricamento semplice e facilitato.

La chambre de combustion en réfractaire de 49 cm de profondeur permet un chargement facile.

Refractory combustion chamber, 49 cm depth, allows easy loading.

Die 49 cm tiefe Feuerfestbeton-Brennkammer ermöglicht eine einfache Beladung.



## Ampio scomparto portaoggetti

*Large storage compartment / Grand compartiment de rangement / Ein großes Ablagefach*

Lo spazio in cucina non è mai sufficiente: per questo sotto il cassetto ceneri è stato ricavato un capiente vano cassetto portaoggetti, l'ideale per appoggiare pentole, mestoli e utensili.

Space in the kitchen is never enough, which is why a large storage compartment has been built under the ash drawer, ideal for storing pots, ladles and utensils.

L'espace dans la cuisine n'est jamais suffisant, c'est pourquoi un grand compartiment de rangement a été aménagé sous le tiroir à cendres, idéal pour ranger les casseroles, les louches et les ustensiles.

Platz ist in der Küche nie genug, deshalb wurde unter der Aschenschublade ein großes Staufach eingebaut, in dem Töpfe, Schöpfkellen und Utensilien aufbewahrt werden können.

POT. 11,2 kW

# LINA 80 LINA 90

LINA 80



LINA 90



Lina maiolica



Lina gres

## Cucina a legna 5 stelle, con ampio forno da 40 litri, porta in vetro e termometro.

La cucina Lina ha una camera di combustione da 49 centimetri di profondità, un ampio vano portaoggetti e cassetto ceneri estraibile. Regolazione separata dell'aria primaria e secondaria.

## Wood-burning cooker with large 40-litre oven, glass door and thermometer.

Lina is a cooker equipped with a 49-cm deep combustion chamber, a large storage compartment, and removable ash drawer. Primary and secondary air are adjusted separately.

## Cuisinière à bois avec grand four de 40 litres, porte vitrée et thermomètre.

Lina est une cuisinière équipée d'une chambre de combustion de 49 cm de profondeur, d'un grand compartiment de rangement et d'un tiroir à cendres amovible. L'air primaire et secondaire sont réglés séparément.

## Holzküche mit großem 40-Liter-Backofen, Glastür und Thermometer.

Der Lina-Herd verfügt über eine 49 cm tiefe Brennkammer, ein großes Ablagefach und eine herausnehmbare Ascheschublade. Getrennte Regelung von Primär- und Sekundärluft.



CLEAN-GLASS SYSTEM



HERMETIC CONSTRUCTION



NOBIS SAFETY STANDARD



ECODESIGN 2022

### Maiolica



Bianco  
White  
Blanc  
Weiß

Bordeaux  
Bordeaux  
Bordeaux  
Bordeaux

### Gres



Grey

Dark





\*

WOOD

-

WEIGHT

205 kg

ENERGY

A+

D.M. 186

★★★★★

F.VERTE

7★



POT. 11,2 kW

# OLGA 80 OLGA 90

OLGA 80



OLGA 90



**Cucina a legna 5 stelle, dal design moderno, con ampio forno da 40 litri, porta in vetro e termometro.**

La cucina Olga ha una camera di combustione da 49 centimetri di profondità, un ampio vano portaoggetti e cassetto ceneri estraibile. Regolazione separata dell'aria primaria e secondaria.

**Cuisinière à bois au design moderne, équipée d'un grand four de 40 litres, d'une porte vitrée et d'un thermomètre.**

Olga est une cuisinière équipée d'une chambre de combustion de 49 cm de profondeur, d'un grand compartiment de rangement et d'un tiroir à cendres amovible. L'air primaire et secondaire sont réglés séparément.

**Wood-burning cooker with a modern design, equipped with a large 40-litre oven, glass door and thermometer.**

Olga is a cooker equipped with a 49-cm deep combustion chamber, a large storage compartment, and a removable ash drawer. Primary and secondary air are adjusted separately.

**Holzbefuerter Herd im modernen Design, mit großem 40-Liter-Backofen, Glastür und Thermometer.**

Der Olga-Herd verfügt über eine 49 cm tiefe Brennkammer, ein großes Ablagefach und eine herausnehmbare Ascheschublade. Getrennte Regelung von Primär- und Sekundärluft.



CLEAN-GLASS SYSTEM



HERMETIC CONSTRUCTION



NOBIS SAFETY STANDARD



ECODESIGN 2022



Bianco  
White  
Blanc  
Weiß



Bordeaux  
Bordeaux  
Bordeaux  
Bordeaux



Nero  
Black  
Noir  
Schwarz



Bronzo  
Bronze  
Bronze  
Bronze





\*

WOOD

-

WEIGHT

195 kg

ENERGY

A+

D.M. 186

★★★★★

F.VERTE

7★

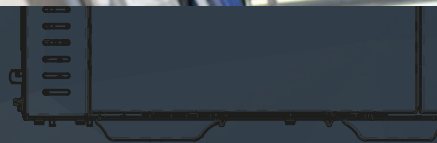

**nobis**  
YOUR STOVE, OUR PASSION

# DATI TECNICI

TECHNICAL DATA | DONNÉES TECHNIQUE | TECHNISCHE DATEN

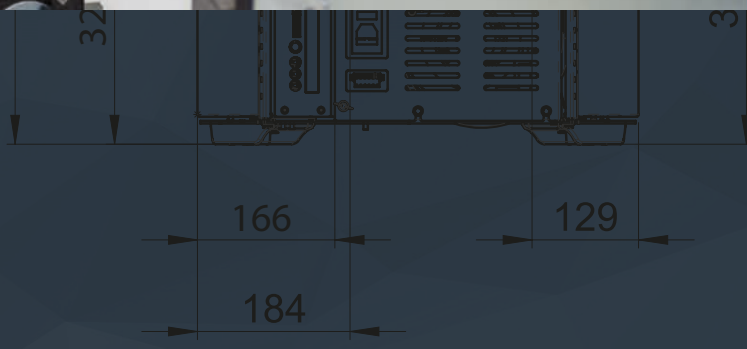

C

B

AL)

A



LIBERA\*



UNICA 10



A8|A10  
ROUND



A8|A10  
ROUND TOP



A8|A10  
ROUND TOP COAX



A8|A10  
ROUND GLASS

Colorazioni - Colours Couleurs - Farben	●●	●●●●●	●●●●●	●●●●●	●●●●●	●●●●●
Convezione - Convection Convection - Konvektion	✓	✓	✓	✓	✓	✓
Ventilazione - Ventilation Ventilation - Belüftung	✓	✓	✓	✓	✓	✓
Canalizzazione Canalization Canalisation Kanalisation	-	<b>KIT</b> Singola - Ø60mm Single - Ø60mm Unique - Ø60mm Einzel - Ø60 mm	<b>KIT</b> Singola - Ø60mm Single - Ø60mm Unique - Ø60mm Einzel - Ø60 mm	<b>KIT</b> Singola - Ø60mm Single - Ø60mm Unique - Ø60mm Einzel - Ø60 mm	<b>KIT</b> Singola - Ø60mm Single - Ø60mm Unique - Ø60mm Einzel - Ø60 mm	<b>KIT</b> Singola - Ø60mm Single - Ø60mm Unique - Ø60mm Einzel - Ø60 mm
Potenza introdotta Power Input Puissance introduite Leistungsaufnahme	4,6 - 10,3 kW	4,6 - 10,3 kW	4,1 - 8,5 kW 4,1 - 10,4 kW	4,1 - 8,5 kW 4,1 - 10,4 kW	4,1 - 8,5 kW 4,1 - 10,4 kW	4,1 - 8,5 kW 4,1 - 10,4 kW
P. termica nominale Nominal heat output P. thermique nominale Nennwärmeleistung	4,2 - 9,3 kW	4,2 - 9,3 kW	3,8 - 7,8 kW 3,8 - 9,5 kW	3,8 - 7,8 kW 3,8 - 9,5 kW	3,8 - 7,8 kW 3,8 - 9,5 kW	3,8 - 7,8 kW 3,8 - 9,5 kW
Potenza all'acqua En. transferred to water P. transmis à l'eau Auf Wasser übertragene En.	-	-	-	-	-	-
LxHxP - WxHxD	55 x 127 x 61 cm	85 x 119 x 48 cm	53 x 113 x 54 cm	53 x 113 x 58 cm	53 x 113 x 58 cm	53 x 113 x 54 cm
Consumo - Consumption - Consommation - Verbrauch	0,96 - 2,17 kg/h	0,96 - 2,17 kg/h	0,8 - 1,7 kg/h 0,8 - 2,2 kg/h	0,8 - 1,7 kg/h 0,8 - 2,2 kg/h	0,8 - 1,7 kg/h 0,8 - 2,2 kg/h	0,8 - 1,7 kg/h 0,8 - 2,2 kg/h
Rendimento - Efficiency - Rendement - Effizienz	90%	90%	92,1 % 90,9 %	92,1 % 90,9 %	92,1 % 90,9 %	92,1 % 90,9 %
Serbatoio - Tank - Réservoir - Tank	15 Kg	18 Kg	19 Kg	15 Kg	15 Kg	19 Kg
Scarico fumi Flue exit pipe Sorties de fumeés Rauchabzugsrohr	Superiore Ø130mm Upper Ø130mm Supérieure Ø130mm Oberer Ø130mm	Superiore Ø130mm Upper Ø130mm Supérieure Ø130mm Oberer Ø130mm	Posteriore - Ø80mm Rear - Ø80mm Arrière - Ø80mm Hinten - Ø80mm	Superiore - Ø80mm Upper - Ø80mm Supérieure - Ø80mm Oberer - Ø80mm	Superiore - Ø80mm Upper - Ø80mm Supérieure - Ø80mm Oberer - Ø80mm	Posteriore - Ø80mm Rear - Ø80mm Arrière - Ø80mm Hinten - Ø80mm
Autonomia - Burn time - Autonomie - Brenndauer	8,3 - 18,8 h	8,3 - 18,8 h	11 - 22 h 9 - 22 h	9 - 17 h 7 - 17 h	9 - 17 h 7 - 17 h	11 - 22 h 9 - 22 h
Pot. elettrica in esercizio Operating power Puissance électrique Betriebsleistung	55/95 W	55/95 W	15/60 W	15/60 W	15/60 W	15/60 W
Peso - Weight - Poids - Gewicht	250 Kg	250 Kg	175 Kg	175 Kg	175 Kg	175 Kg
Wi-Fi	Included	Included	Included	Included	Included	Included
Volume - Heating vol. - Vol. de chauffe - Heizvolumen	228 m <sup>3</sup>	228 m <sup>3</sup>	192 m <sup>3</sup> 233 m <sup>3</sup>	192 m <sup>3</sup> 233 m <sup>3</sup>	192 m <sup>3</sup> 233 m <sup>3</sup>	192 m <sup>3</sup> 233 m <sup>3</sup>
Energy class	A+	A+	A++	A++	A++	A++
D.M. 186	★★★★★	★★★★★	★★★★★	★★★★★	★★★★★	★★★★★
Flamme Verte	7 ★	7 ★	7 ★	7 ★	7 ★	7 ★
DTA	-	-	✓	✓	✓	✓



A8|A10  
ROUND TOP GLASS

A8|A10  
ROUNDTOP GLASS COAX

A8|A10  
ROUND STEEL

A8|A10  
ROUND TOP STEEL

A8|A10  
ROUNDTOP STEEL COAX

B10 V  
ULISSE CLASSIC

Colorazioni - Colours Couleurs - Farben	●●●●	●●●●	●●●	●●●	●●●	-
Convezione - Convection Convection - Konvektion	✓	✓	✓	✓	✓	-
Ventilazione - Ventilation Ventilation - Belüftung	✓	✓	✓	✓	✓	✓
Canalizzazione Canalization Canalisation Kanalisation	<b>KIT</b> Singola - Ø60mm Single - Ø60mm Unique - Ø60mm Einzeln - Ø60 mm	<b>KIT</b> Singola - Ø60mm Single - Ø60mm Unique - Ø60mm Einzeln - Ø60 mm	<b>KIT</b> Singola - Ø60mm Single - Ø60mm Unique - Ø60mm Einzeln - Ø60 mm	<b>KIT</b> Singola - Ø60mm Single - Ø60mm Unique - Ø60mm Einzeln - Ø60 mm	<b>KIT</b> Singola - Ø60mm Single - Ø60mm Unique - Ø60mm Einzeln - Ø60 mm	-
Potenza introdotta Power Input Puisance introduite Leistungsaufnahme	4,1 - 8,5 kW 4,1 - 10,4 kW	4,1 - 8,5 kW 4,1 - 10,4 kW	4,1 - 8,5 kW 4,1 - 10,4 kW	4,1 - 8,5 kW 4,1 - 10,4 kW	4,1 - 8,5 kW 4,1 - 10,4 kW	4,0 - 9,9 kW
P. termica nominale Nominal heat output P. thermique nominale Nennwärmeleistung	3,8 - 7,8 kW 3,8 - 9,5 kW	3,8 - 7,8 kW 3,8 - 9,5 kW	3,8 - 7,8 kW 3,8 - 9,5 kW	3,8 - 7,8 kW 3,8 - 9,5 kW	3,8 - 7,8 kW 3,8 - 9,5 kW	3,5 - 9,0 kW
Potenza all'acqua En. transferred to water P. transmis à l'eau Auf Wasser übertragene En.	-	-	-	-	-	-
LxHxD	53 x 113 x 58 cm	53 x 113 x 58 cm	53 x 113 x 58 cm	53 x 113 x 58 cm	53 x 113 x 58 cm	70 x 62 x 53 cm
Consumo - Consumption - Consommation - Verbrauch	0,8 - 1,7 kg/h 0,8 - 2,2 kg/h	0,8 - 1,7 kg/h 0,8 - 2,2 kg/h	0,8 - 1,7 kg/h 0,8 - 2,2 kg/h	0,8 - 1,7 kg/h 0,8 - 2,2 kg/h	0,8 - 1,7 kg/h 0,8 - 2,2 kg/h	0,8 - 2,1 kg/h
Rendimento - Efficiency - Rendement - Effizienz	92,1 % 90,9 %	92,1 % 90,9 %	92,1 % 90,9 %	92,1 % 90,9 %	92,1 % 90,9 %	90,4 %
Serbatoio - Tank - Réservoir - Tank	15 Kg	15 Kg	15 Kg	15 Kg	15 Kg	12 Kg
Scarico fumi Flue exit pipe Sorties de fumées Rauchabzugsrohr	Superiore - Ø80mm Upper - Ø80mm Supérieure - Ø80mm Oberer - Ø80mm	Superiore - Ø80mm Upper - Ø80mm Supérieure - Ø80mm Oberer - Ø80mm	Posteriore - Ø80mm Rear - Ø80mm Arrière - Ø80mm Hinten - Ø80mm	Superiore - Ø80mm Upper - Ø80mm Supérieure - Ø80mm Oberer - Ø80mm	Superiore - Ø80mm Upper - Ø80mm Supérieure - Ø80mm Oberer - Ø80mm	Superiore - Ø80mm Upper - Ø80mm Supérieure - Ø80mm Oberer - Ø80mm
Autonomia - Burn time - Autonomie - Brenndauer	9 - 17 h 7 - 17 h	9 - 17 h 7 - 17 h	9 - 17 h 7 - 17 h	9 - 17 h 7 - 17 h	9 - 17 h 7 - 17 h	6- 15 h
Pot. elettrica in esercizio Operating power Puisance électrique Betriebsleistung	15/60 W	15/60 W	15/60 W	15/60 W	15/60 W	90 W
Peso - Weight - Poids - Gewicht	175 Kg	175 Kg	175 Kg	175 Kg	175 Kg	95 Kg
Wi-Fi	Included	Included	Optional	Optional	Optional	Optional
Volume - Heating vol. - Vol. de chauffe - Heizvolumen	192 m <sup>3</sup> 233 m <sup>3</sup>	192 m <sup>3</sup> 233 m <sup>3</sup>	192 m <sup>3</sup> 233 m <sup>3</sup>	192 m <sup>3</sup> 233 m <sup>3</sup>	192 m <sup>3</sup> 233 m <sup>3</sup>	221 m <sup>3</sup>
Energy class	A++	A++	A++	A++	A++	A+
D.M. 186	★★★★★	★★★★★	★★★★★	★★★★★	★★★★★	★★★★★
Flamme Verte	7 ★	7 ★	7 ★	7 ★	7 ★	7 ★
DTA	✓	✓	✓	✓	✓	-



**Opzionale con kit**  
 Optional with kit  
 En option avec le kit  
 Optional mit Kit



**A9**  
ZENITH

**A10**  
ZENITH PLUS

**A8**  
QUADRA

**A8**  
QUADRATOP

**A10**  
QUADRA PLUS

**A10**  
QUADRA PLUS TOP

Colorazioni - Colours Couleurs - Farben						
Convezione - Convection Convection - Konvektion	✓	✓	✓	✓	✓	✓
Ventilazione - Ventilation Ventilation - Belüftung	✓	✓	✓	✓	✓	✓
Canalizzazione Canalization Canalisation Kanalisation	 Singola - Ø80mm Single - Ø80mm Unique - Ø80mm Einzel - Ø80 mm	 Singola - Ø80mm Single - Ø80mm Unique - Ø80mm Einzel - Ø80 mm	 Singola - Ø80mm Single - Ø80mm Simple - Ø80mm Einzel - Ø80 mm	 Singola - Ø80mm Single - Ø80mm Simple - Ø80mm Einzel - Ø80 mm	 Singola - Ø80mm Single - Ø80mm Simple - Ø80mm Einzel - Ø80 mm	 Singola - Ø80mm Single - Ø80mm Simple - Ø80mm Einzel - Ø80 mm
Potenza introdotta Power Input Puissance introduite Leistungsaufnahme	4,1 - 9,5 kW	4,1 - 10,4 kW	4,1 - 8,5 kW	4,1 - 8,5 kW	4,1 - 10,4 kW	4,1 - 10,4 kW
P. termica nominale Nominal heat output P. thermique nominale Nennwärmeleistung	3,8 - 8,6 kW	3,8 - 9,5 kW	3,8 - 7,8 kW	3,8 - 7,8 kW	3,8 - 9,5 kW	3,8 - 9,5 kW
Potenza all'acqua En. transferred to water P. transmis à l'eau Auf Wasser übertragene En.	-	-	-	-	-	-
LxHxD - WxHxD	50 x 112 x 51 cm	50 x 112 x 51 cm	44 x 112 x 50 cm	44 x 112 x 56 cm	44 x 112 x 50 cm	44 x 112 x 56 cm
Consumo - Consumption - Consommation - Verbrauch	0,9 - 2 kg/h	0,9 - 2,2 kg/h	0,9 - 1,8 kg/h	0,9 - 1,8 kg/h	0,9 - 2,1 kg/h	0,9 - 2,1 kg/h
Rendimento - Efficiency - Rendement - Effizienz	90,9 %	90,9 %	92,1 %	92,1 %	90,9 %	90,9 %
Serbatoio - Tank - Réservoir - Tank	19 Kg	19 Kg	19 Kg	15 Kg	19 Kg	15 Kg
Scarico fumi Flue exit pipe Sorties de fumeés Rauchabzugsrohr	Posteriore - Ø80mm Rear - Ø80mm Arrière - Ø80mm Hinten - Ø80mm	Posteriore - Ø80mm Rear - Ø80mm Arrière - Ø80mm Hinten - Ø80mm	Posteriore - Ø80mm Rear - Ø80mm Arrière - Ø80mm Hinten - Ø80mm	Superiore - Ø80mm Upper - Ø80mm Supérieure - Ø80mm Oberer - Ø80mm	Posteriore - Ø80mm Rear - Ø80mm Arrière - Ø80mm Hinten - Ø80mm	Superiore - Ø80mm Upper - Ø80mm Supérieure - Ø80mm Oberer - Ø80mm
Autonomia - Burn time - Autonomie - Brenndauer	10 - 22 h	9 - 22 h	11 - 22 h	9 - 17 h	9 - 22 h	7 - 17 h
Pot. elettrica in esercizio Operating power Puissance électrique Betriebsleistung	15/60 W	15/60 W	15/60 W	15/60 W	15/60 W	15/60 W
Peso - Weight - Poids - Gewicht	163 Kg	163 Kg	153 Kg	153 Kg	153 Kg	153 Kg
Wi-Fi	Included	Included	Included	Included	Included	Included
Volume - Heating vol. - Vol. de chauffe - Heizvolumen	211 m <sup>3</sup>	233 m <sup>3</sup>	192 m <sup>3</sup>	192 m <sup>3</sup>	233 m <sup>3</sup>	233 m <sup>3</sup>
Energy class	A++	A++	A++	A++	A++	A++
D.M. 186	★★★★★	★★★★★	★★★★★	★★★★★	★★★★★	★★★★★
Flamme Verte	7 ★	7 ★	7 ★	7 ★	7 ★	7 ★
DTA	✓	✓	✓	✓	✓	✓



A9  
CLASSIC

A10  
CLASSIC PLUS

A8 | A10  
STYLE

A10  
LIGHT

A10  
LIGHT STYLE

A10  
LIGHT 2020

Colorazioni - Colours Couleurs - Farben						
Convezione - Convection Convection - Konvektion	✓	✓	✓	✓	✓	✓
Ventilazione - Ventilation Ventilation - Belüftung	✓	✓	✓	✓	✓	✓
Canalizzazione Canalization Canalisation Kanalisation	<b>KIT</b> Singola - Ø80mm Single - Ø80mm Simple - Ø80mm Einzel - Ø80 mm	<b>KIT</b> Singola - Ø80mm Single - Ø80mm Simple - Ø80mm Einzel - Ø80 mm	<b>KIT</b> Singola - Ø80mm Single - Ø80mm Unique - Ø80mm Einzel - Ø80 mm	Doppia - Ø60mm Double - Ø60mm Double - Ø60mm Doppelt - Ø60 mm	Doppia - Ø60mm Double - Ø60mm Double - Ø60mm Doppelt - Ø60 mm	Doppia - Ø60mm Double - Ø60mm Double - Ø60mm Doppelt - Ø60 mm
Potenza introdotta Power Input Puissance introduite Leistungsaufnahme	4,1 - 9,5 kW	4,1 - 10,4 kW	4,1 - 8,5 kW 4,1 - 10,4 kW	4,1 - 10,4 kW	4,1 - 10,4 kW	4,1 - 10,4 kW
P. termica nominale Nominal heat output P. thermique nominale Nennwärmeleistung	3,8 - 8,6 kW	3,8 - 9,5 kW	3,8 - 7,8 kW 3,8 - 9,5 kW	3,8 - 9,5 kW	3,8 - 9,5 kW	3,8 - 9,5 kW
Potenza all'acqua En. transferred to water P. transmis à l'eau Auf Wasser übertragene En.	-	-	-	-	-	-
LxHxP - WxHxD	53 x 118 x 52 cm	53 x 118 x 52 cm	56 x 112 x 50 cm	76 x 112 x 42 cm	76 x 112 x 42 cm	76 x 112 x 42 cm
Consumo - Consumption - Consommation - Verbrauch	0,9 - 2,0 kg/h	0,9 - 2,1 kg/h	0,9 - 1,8 kg/h 0,9 - 2,1 kg/h	0,8 - 2,2 kg/h	0,8 - 2,2 kg/h	0,8 - 2,2 kg/h
Rendimento - Efficiency - Rendement - Effizienz	90,9 %	90,9 %	92,1 % 90,9 %	90,9 %	90,9 %	90,9 %
Serbatoio - Tank - Réservoir - Tank	19 Kg	19 Kg	19 Kg	35 Kg	35 Kg	35 Kg
Scarico fumi Flue exit pipe Sorties de fumées Rauchabzugsrohr	Posteriore - Ø80mm Rear - Ø80mm Arrière - Ø80mm Hinten - Ø80mm	Posteriore - Ø80mm Rear - Ø80mm Arrière - Ø80mm Hinten - Ø80mm	Posteriore - Ø80mm Rear - Ø80mm Arrière - Ø80mm Hinten - Ø80mm	Posteriore - Ø80mm Rear - Ø80mm Arrière - Ø80mm Hinten - Ø80mm	Posteriore - Ø80mm Rear - Ø80mm Arrière - Ø80mm Hinten - Ø80mm	Posteriore - Ø80mm Rear - Ø80mm Arrière - Ø80mm Hinten - Ø80mm
Autonomia - Burn time - Autonomie - Brenndauer	10 - 22 h	9 - 22 h	11 - 22 h 9 - 22 h	16-41 h	16-41 h	16-41 h
Pot. elettrica in esercizio Operating power Puissance électrique Betriebsleistung	15/60 W	15/60 W	15/60 W	60 W	60 W	60 W
Peso - Weight - Poids - Gewicht	185 Kg	185 Kg	180 Kg	210 Kg	210 Kg	210 Kg
Wi-Fi	Included	Included	Included	Included	Included	Included
Volume - Heating vol. - Vol. de chauffe - Heizvolumen	211 m <sup>3</sup>	233 m <sup>3</sup>	233 m <sup>3</sup>	233 m <sup>3</sup>	233 m <sup>3</sup>	233 m <sup>3</sup>
Energy class	A++	A++	A++	A++	A++	A++
D.M. 186	★★★★★	★★★★★	★★★★★	★★★★★	★★★★★	★★★★★
Flamme Verte	7 ★	7 ★	7 ★	7 ★	7 ★	7 ★
DTA	✓	✓	-	✓	✓	✓





**Opzionale con kit**  
 Optional with kit  
 En option avec le kit  
 Optional mit Kit



7|10  
LISA



12  
ELENA



12  
ELENA STYLE



A11|A13  
ROUND



A11|A13  
ROUND TOP



A11|A13  
ROUND TOP COAX

Colorazioni - Colours Couleurs - Farben						
Convezione - Convection Convection - Konvektion	-	✓	✓	✓	✓	✓
Ventilazione - Ventilation Ventilation - Belüftung	✓	✓	✓	✓	✓	✓
Canalizzazione Canalization Canalisation Kanalisation	<b>KIT</b> Singola - Ø60mm Single - Ø60mm Unique - Ø60mm Einzel - Ø60 mm	<b>KIT</b> Singola - Ø60mm Single - Ø60mm Unique - Ø60mm Einzel - Ø60 mm	<b>KIT</b> Singola - Ø60mm Single - Ø60mm Unique - Ø60mm Einzel - Ø60 mm	<b>KIT</b> Doppia - Ø60mm Double - Ø60mm Double - Ø60mm Doppelt - Ø60mm	<b>KIT</b> Singola - Ø60mm Single - Ø60mm Simple - Ø60mm Einzel - Ø60 mm	<b>KIT</b> Singola - Ø60mm Single - Ø60mm Simple - Ø60mm Einzel - Ø60 mm
Potenza introdotta Power Input Puissance introduite Leistungsaufnahme	3,8 - 7,7 kW 3,8 - 10,5 kW	5,2 - 12,5 kW	5,2 - 12,5 kW	4,9 - 11,0 kW 4,9 - 12,9 kW	4,9 - 11,0 kW 4,9 - 12,9 kW	4,9 - 11,0 kW 4,9 - 12,9 kW
P. termica nominale Nominal heat output P. thermique nominale Nennwärmeleistung	3,4 - 7,0 kW 3,4 - 9,3 kW	4,6 - 11,2 kW	4,6 - 11,2 kW	4,6 - 10,2 kW 4,6 - 11,8 kW	4,6 - 10,2 kW 4,6 - 11,8 kW	4,6 - 10,2 kW 4,6 - 11,8 kW
Potenza all'acqua En. transferred to water P. transmis à l'eau Auf Wasser übertragene En.	-	-	-	-	-	-
LxHxD - WxHxD	45 x 107 x 54 cm	71 x 119 x 36 cm	78 x 119 x 36 cm	53 x 125 x 54 cm	53 x 125 x 57 cm	53 x 125 x 57 cm
Consumo - Consumption - Consommation - Verbrauch	0,8 - 1,6 kg/h 0,8 - 2,2 kg/h	1,1 - 2,6 kg/h	1,1 - 2,6 kg/h	1,0 - 2,3 kg/h 1,1 - 2,8 kg/h	1,0 - 2,3 kg/h 1,1 - 2,8 kg/h	1,0 - 2,3 kg/h 1,1 - 2,8 kg/h
Rendimento - Efficiency - Rendement - Effizienz	90,6 % 89,6 %	90,9 %	90,9 %	92,5 % 91,2 %	92,5 % 91,2 %	92,5 % 91,2 %
Serbatoio - Tank - Réservoir - Tank	16 Kg	19 Kg	19 Kg	20 Kg	17 Kg	17 Kg
Scarico fumi Flue exit pipe Sorties de fumeés Rauchabzugsrohr	Posteriore - Ø80mm Rear - Ø80mm Arrière - Ø80mm Hinten - Ø80mm	Posteriore - Ø80mm Rear - Ø80mm Arrière - Ø80mm Hinten - Ø80mm	Posteriore - Ø80mm Rear - Ø80mm Arrière - Ø80mm Hinten - Ø80mm	Posteriore - Ø80mm Rear - Ø80mm Arrière - Ø80mm Hinten - Ø80mm	Superiore - Ø80mm Upper - Ø80mm Supérieure - Ø80mm Oberer - Ø80mm	Superiore - Ø80mm Upper - Ø80mm Supérieure - Ø80mm Oberer - Ø80mm
Autonomia - Burn time - Autonomie - Brenndauer	10 - 20 h 7 - 20 h	9 - 21 h	9 - 21 h	9 - 20 h 7 - 19 h	7 - 17 h 6 - 17 h	7 - 17 h 6 - 17 h
Pot. elettrica in esercizio Operating power Puissance électrique Betriebsleistung	55/65 W	60/65 W	60/65 W	35/110 W	35/110 W	35/110 W
Peso - Weight - Poids - Gewicht	120 Kg	130 Kg	130 Kg	160 Kg	183 Kg	183 Kg
Wi-Fi	Optional	Optional	Optional	Included	Included	Included
Volume - Heating vol. - Vol. de chauffe - Heizvolumen	172 m <sup>3</sup> 228 m <sup>3</sup>	275 m <sup>3</sup>	275 m <sup>3</sup>	251 m <sup>3</sup> 290 m <sup>3</sup>	251 m <sup>3</sup> 290 m <sup>3</sup>	251 m <sup>3</sup> 290 m <sup>3</sup>
Energy class	A+	A+	A+	A++ A+	A++ A+	A++ A+
D.M. 186	★★★★★	★★★★★	★★★★★	★★★★★	★★★★★	★★★★★
Flamme Verte	7 ★	7 ★	7 ★	7 ★	7 ★	7 ★
DTA	-	-	-	✓	-	-

 A11|A13  
ROUND GLASS

 A11|A13  
ROUND TOP GLASS

 A11|A13  
ROUNDTOP GLASS COAX

 A11|A13  
ZENITH

 A11|A13  
ZENITH PLUS

 B10 V  
ULISSE

Colorazioni - Colours Couleurs - Farben	●●●●	●●●●	●●●●	●●●●	●●●●	-
Convezione - Convection Convection - Konvektion	✓	✓	✓	✓	✓	-
Ventilazione - Ventilation Ventilation - Belüftung	✓	✓	✓	✓	✓	✓
Canalizzazione Canalization Canalisation Kanalisation	<b>KIT</b> Doppia - Ø60mm Double - Ø60mm Double - Ø60mm Doppelt - Ø60mm	<b>KIT</b> Singola - Ø60mm Single - Ø60mm Unique - Ø60mm Einzel - Ø60 mm	<b>KIT</b> Singola - Ø60mm Single - Ø60mm Unique - Ø60mm Einzel - Ø60 mm	<b>KIT</b> Doppia - Ø60mm Double - Ø60mm Double - Ø60mm Doppelt - Ø60mm	<b>KIT</b> Doppia - Ø60mm Double - Ø60mm Double - Ø60mm Doppelt - Ø60mm	-
Potenza introdotta Power Input Puissance introduite Leistungsaufnahme	4,9 - 11,0 kW 4,9 - 12,9 kW	4,9 - 11,0 kW 4,9 - 12,9 kW	4,9 - 11,0 kW 4,9 - 12,9 kW	4,9 - 11 kW 4,9 - 12,9 kW	4,9 - 11 kW 4,9 - 12,9 kW	4,0 - 9,9 kW
P. termica nominale Nominal heat output P. thermique nominale Nennwärmeleistung	4,6 - 10,2 kW 4,6 - 11,8 kW	4,6 - 10,2 kW 4,6 - 11,8 kW	4,6 - 10,2 kW 4,6 - 11,8 kW	4,6 - 10,2 kW 4,6 - 11,8 kW	4,6 - 10,2 kW 4,6 - 11,8 kW	3,5 - 9,0 kW
Potenza all'acqua En. transferred to water P. transmis à l'eau Auf Wasser übertragene En.	-	-	-	-	-	-
LxHxD - WxHxD	53 x 125 x 54 cm	53 x 125 x 57 cm	53 x 125 x 57 cm	52 x 121 x 54 cm	52 x 121 x 54 cm	69 x 50 x 49 cm
Consumo - Consumption - Consommation - Verbrauch	1,0 - 2,3 kg/h 1,1 - 2,8 kg/h	1,0 - 2,3 kg/h 1,1 - 2,8 kg/h	1,0 - 2,3 kg/h 1,1 - 2,8 kg/h	1,0 - 2,3 kg/h 1,1 - 2,8 kg/h	1,0 - 2,3 kg/h 1,1 - 2,8 kg/h	0,8 - 2,1 kg/h
Rendimento - Efficiency - Rendement - Effizienz	92,5 % 91,2 %	92,5 % 91,2 %	92,5 % 91,2 %	92,5 % 91,2 %	92,5 % 91,2 %	90,4 %
Serbatoio - Tank - Réservoir - Tank	20 Kg	17 Kg	17 Kg	22 Kg	22 Kg	12 Kg
Scarico fumi Flue exit pipe Sorties de fumeés Rauchabzugsrohr	Posteriore - Ø80mm Rear - Ø80mm Arrière - Ø80mm Hinten - Ø80mm	Superiore - Ø80mm Upper - Ø80mm Supérieure - Ø80mm Oberer - Ø80mm	Superiore - Ø80mm Upper - Ø80mm Supérieure - Ø80mm Oberer - Ø80mm	Posteriore - Ø80mm Rear - Ø80mm Arrière - Ø80mm Hinten - Ø80mm	Posteriore - Ø80mm Rear - Ø80mm Arrière - Ø80mm Hinten - Ø80mm	Superiore - Ø80mm Upper - Ø80mm Supérieure - Ø80mm Oberer - Ø80mm
Autonomia - Burn time - Autonomie - Brenndauer	9 - 20 h 7 - 19 h	7 - 17 h 6 - 17 h	7 - 17 h 6 - 17 h	10 - 22 h 8 - 22 h	10 - 22 h 8 - 22 h	6- 15 h
Pot. elettrica in esercizio Operating power Puissance électrique Betriebsleistung	35/110 W	35/110 W	35/110 W	35/110W	35/110W	90 W
Peso - Weight - Poids - Gewicht	160 Kg	183 Kg	183 Kg	183 Kg	183 Kg	95 Kg
Wi-Fi	Included	Included	Included	Included	Included	Optional
Volume - Heating vol. - Vol. de chauffe - Heizvolumen	251 m <sup>3</sup> 290 m <sup>3</sup>	251 m <sup>3</sup> 290 m <sup>3</sup>	251 m <sup>3</sup> 290 m <sup>3</sup>	251 m <sup>3</sup> 290 m <sup>3</sup>	251 m <sup>3</sup> 290 m <sup>3</sup>	221 m <sup>3</sup>
Energy class	A++ A+	A++ A+	A++ A+	A++ A+	A++ A+	A+
D.M. 186	★★★★★	★★★★★	★★★★★	★★★★★	★★★★★	★★★★★
Flamme Verte	7 ★	7 ★	7 ★	7 ★	7 ★	7 ★
DTA	✓	-	-	✓	✓	-



**Opzionale con kit**  
 Optional with kit  
 En option avec le kit  
 Optional mit Kit



**B10C  
ULISSE**



**B13C  
ULISSE**



**HB14|17V  
ULISSE**



**H10|H12  
SHAPE**



**H10|H12  
SHAPE GLASS**



**H14|H17  
SHAPE ROUND**

Colorazioni - Colours Couleurs - Farben	-					
Convezione - Convection Convection - Konvektion	-	-	-	-	-	-
Ventilazione - Ventilation Ventilation - Belüftung	✓	✓	✓	✓	✓	✓
Canalizzazione Canalization Canalisation Kanalisation	<b>KIT</b> Singola - Ø60mm Single - Ø60mm Unique - Ø60mm Einzeln - Ø60 mm	<b>KIT</b> Doppia - Ø60mm Double - Ø60mm Double - Ø60mm Doppelt - Ø60mm	-	-	-	-
Potenza introdotta Power Input Puissance introduite Leistungsaufnahme	4,0 - 9,9 kW	5,2 - 12,5 kW	8,8 - 18,9 kW 8,8 - 21,2 kW	6,8 - 14,2 kW 6,8 - 16,8 kW	6,8 - 14,2 kW 6,8 - 16,8 kW	8,8 - 18,9 kW 8,8 - 21,2 kW
P. termica nominale Nominal heat output P. thermique nominale Nennwärmeleistung	3,5 - 9,0 kW	4,6 - 11,2 kW	8,4 - 17,8 kW 8,4 - 19,8 kW	6,4 - 13,3 kW 6,4 - 15,5 kW	6,4 - 13,3 kW 6,4 - 15,5 kW	8,4 - 17,8 kW 8,4 - 19,8 kW
Potenza all'acqua En. transferred to water P. transmis à l'eau Auf Wasser übertragene En.	-	-	6,6 - 14,6 kW 6,6 - 16,9 kW	4,8 - 10 kW 4,8 - 12 kW	4,8 - 10 kW 4,8 - 12 kW	6,6 - 14,6 kW 6,6 - 16,9 kW
LxHxD - WxHxD	69 x 50 x 58 cm	83 x 120 x 62 cm	83 x 120 x 62 cm	53 x 113 x 60 cm	53 x 113 x 60 cm	54 x 123 x 57 cm
Consumo - Consumption - Consommation - Verbrauch	0,8 - 2,1 kg/h	1,1 - 2,6 kg/h	1,9 - 4,0 kg/h 1,9 - 4,5 kg/h	1,4 - 2,9 kg/h 1,4 - 3,4 kg/h	1,4 - 2,9 kg/h 1,4 - 3,4 kg/h	1,9 - 4 kg/h 1,9 - 4,5 kg/h
Rendimento - Efficiency - Rendement - Effizienz	90,4 %	89,2 %	94,2 % 93,5 %	93,9 % 92,6 %	93,9 % 92,6 %	94,2 % 93,5 %
Serbatoio - Tank - Réservoir - Tank	14 Kg	35 Kg	28 Kg	20 Kg	20 Kg	22 Kg
Scarico fumi Flue exit pipe Sorties de fumeés Rauchabzugsrohr	Superiore - Ø80mm Upper - Ø80mm Supérieure - Ø80mm Oberer - Ø80mm	Posteriore, superiore Rear, upper Arrière, supérieure Hinten, oben (Ø80mm)	Superiore Ø80mm Upper Ø80mm Supérieure Ø80mm Oberer Ø80mm	Posteriore - Ø80mm Rear - Ø80mm Arrière - Ø80mm Hinten - Ø80mm	Posteriore - Ø80mm Rear - Ø80mm Arrière - Ø80mm Hinten - Ø80mm	Posteriore - Ø80mm Rear - Ø80mm Arrière - Ø80mm Hinten - Ø80mm
Autonomia - Burn time - Autonomie - Brenndauer	7 - 17 h	13 - 32 h	7 - 15 h 6 - 15 h	7 - 15 h 6 - 15 h	7 - 15 h 6 - 15 h	5 - 12 h 5 - 2 h
Pot. elettrica in esercizio Operating power Puissance électrique Betriebsleistung	90 W	60/65 W	16 W 19 W	16 W 20 W	16 W 20 W	16 W 19 W
Peso - Weight - Poids - Gewicht	110 Kg	160 Kg	220 Kg	165 Kg	165 Kg	185 Kg/220 Kg
Wi-Fi	Optional	Included	Included	Included	Included	Included
Volume - Heating vol. - Vol. de chauffe - Heizvolumen	221 m <sup>3</sup>	275 m <sup>3</sup>	437 m <sup>3</sup> 486 m <sup>3</sup>	327 m <sup>3</sup> 381 m <sup>3</sup>	327 m <sup>3</sup> 381 m <sup>3</sup>	457 m <sup>3</sup> 486 m <sup>3</sup>
Energy class	A+	A+	A++	A++	A++	A++
D.M. 186	★★★★★	★★★★	★★★★★	★★★★★	★★★★★	★★★★★
Flamme Verte	7 ★	7 ★	7 ★	7 ★	7 ★	7 ★
DTA	-	-	-	-	-	-



H14  
SHAPE

H17  
SHAPEMAIOLICA/STEEL

H17  
LIGHT

H20  
SHAPEMAIOLICA/STEEL

H25  
SHAPEMAIOLICA/STEEL

POLYGON 25

Colorazioni - Colours Couleurs - Farben						-
Convezione - Convection Convection - Konvektion	-	-	-	-	-	-
Ventilazione - Ventilation Ventilation - Belüftung	✓	✓	✓	✓	✓	-
Canalizzazione Canalization Canalisation Kanalisation	-	-	-	-	-	-
Potenza introdotta Power Input Puissance introduite Leistungsaufnahme	8,8 - 18,9 kW	8,8 - 21,2 kW	8,5 - 21,6 kW	11 - 23,8 kW	11 - 30 kW	7,9 - 26,9 kW
P. termica nominale Nominal heat output P. thermique nominale Nennwärmeleistung	8,4 - 17,8 kW	8,4 - 19,8 kW	7,9 - 20 kW	10,2 - 22,2 kW	10,2 - 27,7 kW	7,2 - 24,7 kW
Potenza all'acqua En. transferred to water P. transmis à l'eau Auf Wasser übertragene En.	6,6 - 14,6 kW	6,6 - 16,9 kW	6,4 - 17 kW	8,4 - 20,1 kW	8,4 - 25,1 kW	7,2 - 24,7 kW
LxHxD - WxHxD	54 x 123 x 57 cm	54 x 123 x 57 cm	94 x 112 x 35 cm	57 x 130 x 66 cm	57 x 130 x 66 cm	105 x 140 x 62 cm
Consumo - Consumption - Consommation - Verbrauch	1,9 - 4,05 kg/h	1,9 - 4,5 kg/h	1,8 - 4,4 kg/h	2,3 - 4,9 kg/h	2,3 - 6,2 kg/h	1,6 - 5,6 kg/h
Rendimento - Efficiency - Rendement - Effizienz	94,2 %	93,5%	93,3 %	93,6 %	92,3 %	92 %
Serbatoio - Tank - Réservoir - Tank	21 Kg	21 Kg	25 Kg	37 Kg	37 Kg	75 Kg
Scarico fumi Flue exit pipe Sorties de fumeés Rauchabzugsrohr	Posteriore - Ø80mm Rear - Ø80mm Arrière - Ø80mm Hinten - Ø80mm	Posteriore - Ø80mm Rear - Ø80mm Arrière - Ø80mm Hinten - Ø80mm	Posteriore - Ø80mm Rear - Ø80mm Arrière - Ø80mm Hinten - Ø80mm	Posteriore - Ø100mm Rear - Ø100mm Arrière - Ø100mm Hinten - Ø100mm	Posteriore - Ø100mm Rear - Ø100mm Arrière - Ø100mm Hinten - Ø100mm	Posteriore, superiore Rear, upper Arrière, supérieure Hinten, oben (Ø100mm)
Autonomia - Burn time - Autonomie - Brenndauer	5 - 11 h	5 - 11 h	5 - 15 h	7 - 16 h	6 - 16 h	13- 46 h
Pot. elettrica in esercizio Operating power Puissance électrique Betriebsleistung	16 W	19 W	23 W	32 W	37 W	118 W
Peso - Weight - Poids - Gewicht	185 Kg	220 Kg	210 Kg	260 Kg	273 Kg	350 Kg
Wi-Fi	Included	Included	Included	Included	Included	Included
Volume - Heating vol. - Vol. de chauffe - Heizvolumen	437 m <sup>3</sup>	486 m <sup>3</sup>	491 m <sup>3</sup>	545 m <sup>3</sup>	681 m <sup>3</sup>	607 m <sup>3</sup>
Energy class	A++	A++	A++	A++	A++	A+
D.M. 186	★★★★★	★★★★★	★★★★★	★★★★★	★★★★★	★★★★★
Flamme Verte	7 ★	7 ★	7 ★	7 ★	7 ★	-
DTA	-	-	-	-	-	-

**KIT**

**Opzionale con kit**  
Optional with kit  
En option avec le kit  
Optional mit Kit



POLYGON 28



POLYGON 32



EFREM CLASSIC 700<sup>49\*</sup>



EFREM CLASSIC 800<sup>55\*</sup>



8|10  
FLAT 100



8|10  
FLAT 300/FLAT 330

Colorazioni - Colours Couleurs - Farben	-	-	-	-	-	
Convezione - Convection Convection - Konvektion	-	-	✓	✓	✓	✓
Ventilazione - Ventilation Ventilation - Belüftung	-	-	-	-	-	Frontale Front Avant Front
Canalizzazione Canalization Canalisation Kanalisation	-	-	-	-	-	Singola - Ø60mm Single - Ø60mm Unique - Ø60mm Einzeln - Ø60 mm
Potenza introdotta Power Input Puisance introduite Leistungsaufnahme	7,9 - 29,3 kW	7,9 - 31,5 kW	10 kW	10,5 kW*	8,5   10,2 kW	8,5   10,2 kW
P. termica nominale Nominal heat output P. thermique nominale Nennwärmeleistung	7,2 - 27 kW	7,2 - 29 kW	8,5 kW	8,5 kW	7,2   8,8 kW	7,2   8,8 kW
Potenza all'acqua En. transferred to water P. transmis à l'eau Auf Wasser übertragene En.	7,2 - 27 kW	7,2 - 29 kW	-	-	-	-
LxHxP - WxHxD	105 x 140 x 62 cm	105 x 140 x 62 cm	67 x 60 x 45 cm	77 x 66 x 45 cm	52 x 79 x 45 cm	48 x 120 x 45 cm
Consumo - Consumption - Consumption - Verbrauch	1,6 - 6,11 kg/h	1,6 - 6,5 kg/h	2,4 kg/h	2,4 kg/h	2,0 kg/h 2,4 kg/h	2,0 kg/h 2,4 kg/h
Rendimento - Efficiency - Rendement - Effizienz	92,2 %	92,2 %	85,6 %	85,6 %	85 % 86,1 %	85 % 86,1 %
Serbatoio - Tank - Réservoir - Tank	75 Kg	125 Kg	-	-	-	-
Scarico fumi Flue exit pipe Sorties de fumeés Rauchabzugsrohr	Posteriore, superiore Rear, upper Arrière, supérieure Hinten, oben (Ø100mm)	Posteriore, superiore Rear, upper Arrière, supérieure Hinten, oben (Ø100mm)	Superiore Ø150mm Upper Ø150mm Supérieure Ø150mm Oberer Ø150mm	Superiore Ø150mm Upper Ø150mm Supérieure Ø150mm Oberer Ø150mm	Superiore Ø150mm Upper Ø150mm Supérieure Ø150mm Oberer Ø150mm	Superiore Ø150mm Upper Ø150mm Supérieure Ø150mm Oberer Ø150mm
Autonomia - Burn time - Autonomie - Brenndauer	12 - 46 h	11 - 46 h	-	-	-	-
Pot. elettrica in esercizio Operating power Puisance électrique Betriebsleistung	121 W	124 W	-	-	-	-
Peso - Weight - Poids - Gewicht	350 Kg	350 Kg	80 Kg	80 Kg	145 Kg	165 Kg
Wi-Fi	Included	Included	-	-	-	-
Volume - Heating vol. - Vol. de chauffe - Heizvolumen	663 m <sup>3</sup>	712 m <sup>3</sup>	209 m <sup>3</sup>	209 m <sup>3</sup>	177 m <sup>3</sup> 216 m <sup>3</sup>	177 m <sup>3</sup> 216 m <sup>3</sup>
Energy class	A+	A+	A+	A+	A+	A+
D.M. 186	★★★★★	★★★★★	★★★★★	★★★★★	★★★★★	★★★★★
Flamme Verte	-	-	7 ★	7 ★	7 ★	7 ★
DTA	-	-	-	-	-	-



8|10  
FLAT 500/FLAT 550

8|10  
FLAT 700/FLAT 770

8|10  
ZENITH 400/ZENITH 440

8|10  
ZENITH 600/ZENITH 660

8|10  
ZENITH 800/ZENITH 880

8|10  
CLASSIC 200/CLASSIC 220

Colorazioni - Colours Couleurs - Farben						
Convezione - Convection Convection - Konvektion						
Ventilazione - Ventilation Ventilation - Belüftung	 Frontale Front Avant Front	 Frontale Front Avant Front	 Frontale Front Avant Front	 Frontale Front Avant Front	 Frontale Front Avant Front	 Frontale Front Avant Front
Canalizzazione Canalization Canalisation Kanalisation	 Singola - Ø60mm Single - Ø60mm Unique - Ø60mm Einzel - Ø60 mm	 Singola - Ø60mm Single - Ø60mm Unique - Ø60mm Einzel - Ø60 mm	 Singola - Ø60mm Single - Ø60mm Unique - Ø60mm Einzel - Ø60 mm	 Singola - Ø60mm Single - Ø60mm Unique - Ø60mm Einzel - Ø60 mm	 Singola - Ø60mm Single - Ø60mm Unique - Ø60mm Einzel - Ø60 mm	 Singola - Ø60mm Single - Ø60mm Unique - Ø60mm Einzel - Ø60 mm
Potenza introdotta Power Input Puissance introduite Leistungsaufnahme	8,5   10,2 kW	8,5   10,2 kW	8,5   10,2 kW	8,5   10,2 kW	8,5   10,2 kW	8,5   10,2 kW
P. termica nominale Nominal heat output P. thermique nominale Nennwärmeleistung	7,2   8,8 kW	7,2   8,8 kW	7,2   8,8 kW	7,2   8,8 kW	7,2   8,8 kW	7,2   8,8 kW
Potenza all'acqua En. transferred to water P. transmis à l'eau Auf Wasser übertragene En.	-	-	-	-	-	-
LxHxP - WxHxD	48 x 120 x 45 cm	48 x 120 x 45 cm	53 x 120 x 48 cm	53 x 120 x 48 cm	53 x 125 x 48 cm	51 x 125 x 47 cm
Consumo - Consumption - Consumation - Verbrauch	2,0 kg/h 2,4 kg/h	2,0 kg/h 2,4 kg/h	2,0 kg/h 2,4 kg/h	2,0 kg/h 2,4 kg/h	2,0 kg/h 2,4 kg/h	2,0 kg/h 2,4 kg/h
Rendimento - Efficiency - Rendement - Effizienz	85 % 86,1 %	85 % 86,1 %	85 % 86,1 %	85 % 86,1 %	85 % 86,1 %	85 % 86,1 %
Serbatoio - Tank - Réservoir - Tank	-	-	-	-	-	-
Scarico fumi Flue exit pipe Sorties de fumeés Rauchabzugsrohr	Superiore Ø150mm Upper Ø150mm Supérieure Ø150mm Oberer Ø150mm	Superiore Ø150mm Upper Ø150mm Supérieure Ø150mm Oberer Ø150mm	Superiore Ø150mm Upper Ø150mm Supérieure Ø150mm Oberer Ø150mm	Superiore Ø150mm Upper Ø150mm Supérieure Ø150mm Oberer Ø150mm	Superiore Ø150mm Upper Ø150mm Supérieure Ø150mm Oberer Ø150mm	Superiore Ø150mm Upper Ø150mm Supérieure Ø150mm Oberer Ø150mm
Autonomia - Burn time - Autonomie - Brenndauer	-	-	-	-	-	-
Pot. elettrica in esercizio Operating power Puissance électrique Betriebsleistung	-	-	-	-	-	-
Peso - Weight - Poids - Gewicht	165 Kg	165 Kg	165 Kg	165 Kg	165 Kg	165 Kg
Wi-Fi	-	-	-	-	-	-
Volume - Heating vol. - Vol. de chauffe - Heizvolumen	177 m <sup>3</sup> 216 m <sup>3</sup>	177 m <sup>3</sup> 216 m <sup>3</sup>	177 m <sup>3</sup> 216 m <sup>3</sup>	177 m <sup>3</sup> 216 m <sup>3</sup>	177 m <sup>3</sup> 216 m <sup>3</sup>	177 m <sup>3</sup> 216 m <sup>3</sup>
Energy class	A+	A+	A+	A+	A+	A+
D.M. 186	★★★★★	★★★★★	★★★★★	★★★★★	★★★★★	★★★★★
Flamme Verte	7 ★	7 ★	7 ★	7 ★	7 ★	7 ★
DTA	-	-	-	-	-	-



**Opzionale con kit**  
 Optional with kit  
 En option avec le kit  
 Optional mit Kit



EFREM700.49

EFREM800.49\*

EFREM900.49\*

EFREM700.55

EFREM800.55\*

EFREM900.55\*

Colorazioni - Colours Couleurs - Farben	-	-	-	-	-	-
Convezione - Convection Convection - Konvektion	✓	✓	✓	✓	✓	✓
Ventilazione - Ventilation Ventilation - Belüftung	Frontale Front Avant Front	Frontale Front Avant Front	Frontale Front Avant Front	Frontale Front Avant Front	Frontale Front Avant Front	Frontale Front Avant Front
Canalizzazione Canalisation Kanalisation	Doppia - Ø120mm Double - Ø120mm Double - Ø120mm Doppelt - Ø120mm	Doppia - Ø120mm Double - Ø120mm Double - Ø120mm Doppelt - Ø120mm	Doppia - Ø120mm Double - Ø120mm Double - Ø120mm Doppelt - Ø120mm	Doppia - Ø120mm Double - Ø120mm Double - Ø120mm Doppelt - Ø120mm	Doppia - Ø120mm Double - Ø120mm Double - Ø120mm Doppelt - Ø120mm	Doppia - Ø120mm Double - Ø120mm Double - Ø120mm Doppelt - Ø120mm
Potenza introdotta Power Input Puissance introduite Leistungsaufnahme	10 kW	10,5 kW	11 kW*	10 kW	10,5 kW*	11 kW*
P. termica nominale Nominal heat output P. thermique nominale Nennwärmeleistung	8,5 kW	9 kW	9,5 kW	8,5 kW	9 kW	9,5 kW
Potenza all'acqua En. transferred to water P. transmis à l'eau Auf Wasser übertragene En.	-	-	-	-	-	-
LxHxD	66 x 49 x 38 cm	76 x 49 x 38 cm	86 x 49 x 38 cm	66 x 55 x 38 cm	76 x 55 x 38 cm	86 x 55 x 38 cm
Consumo - Consumption - Consommation - Verbrauch	2,4 kg/h	2,4 kg/h	2,4 kg/h	2,4 kg/h	2,4 kg/h	2,4 kg/h
Rendimento - Efficiency - Rendement - Effizienz	85,6 %	85,6 %	85,6 %	85,6 %	85,6 %	85,6 %
Serbatoio - Tank - Réservoir - Tank	-	-	-	-	-	-
Scarico fumi Flue exit pipe Sorties de fumées Rauchabzugsrohr	Superiore Ø150mm Upper Ø150mm Supérieure Ø150mm Oberer Ø150mm	Superiore Ø150mm Upper Ø150mm Supérieure Ø150mm Oberer Ø150mm	Superiore Ø150mm Upper Ø150mm Supérieure Ø150mm Oberer Ø150mm	Superiore Ø150mm Upper Ø150mm Supérieure Ø150mm Oberer Ø150mm	Superiore Ø150mm Upper Ø150mm Supérieure Ø150mm Oberer Ø150mm	Superiore Ø150mm Upper Ø150mm Supérieure Ø150mm Oberer Ø150mm
Autonomia - Burn time - Autonomie - Brenndauer	-	-	-	-	-	-
Pot. elettrica in esercizio Operating power Puissance électrique Betriebsleistung	-	-	-	-	-	-
Peso - Weight - Poids - Gewicht	80 Kg	80 Kg	80 Kg	80 Kg	80 Kg	80 Kg
Wi-Fi	-	-	-	-	-	-
Volume - Heating vol. - Vol. de chauffe - Heizvolumen	209 m <sup>3</sup>	209 m <sup>3</sup>	209 m <sup>3</sup>	209 m <sup>3</sup>	209 m <sup>3</sup>	209 m <sup>3</sup>
Energy class	A+	A+	A+	A+	A+	A+
D.M. 186	★★★★★	★★★★★	★★★★★	★★★★★	★★★★★	★★★★★
Flamme Verte	7 ★	7 ★	7 ★	7 ★	7 ★	7 ★
DTA	-	-	-	-	-	-



	EFREM FLY 700 <sup>49*</sup>	EFREM FLY 800 <sup>55*</sup>	LINA 80 GRES*	LINA 90 / LINA 90 GRES*	OLGA 80*	OLGA 90*
Colorazioni - Colours Couleurs - Farben	-	-	● ●	● ● ● ●	● ● ● ●	● ● ● ●
Convezione - Convection Convection - Konvektion	✓	✓	✓	✓	✓	✓
Ventilazione - Ventilation Ventilation - Belüftung	-	-	-	-	-	-
Canalizzazione Canalization Canalisation Kanalisation	-	-	-	-	-	-
Potenza introdotta Power Input Puissance introduite Leistungsaufnahme	10 kW	10,5 kW*	11,2 kW	11,2 kW	11,2 kW	11,2 kW
P. termica nominale Nominal heat output P. thermique nominale Nennwärmeleistung	8,5 kW	9 kW	9,5 kW	9,5 kW	9,5 kW	9,5 kW
Potenza all'acqua En. transferred to water P. transmis à l'eau Auf Wasser übertragene En.	-	-	-	-	-	-
LxHxD - WxHxD	66 x 49 x 38 cm	76 x 55 x 38 cm	83 x 85 x 60 cm	93 x 85 x 60 cm	83 x 85 x 60 cm	93 x 85 x 60 cm
Consumo - Consumption - Consommation - Verbrauch	2,4 kg/h	2,4 kg/h	2,6 kg/h	2,6 kg/h	2,6 kg/h	2,6 kg/h
Rendimento - Efficiency - Rendement - Effizienz	85,6 %	85,6 %	85,8 %	85,8 %	85,8 %	85,8 %
Serbatoio - Tank - Réservoir - Tank	-	-	-	-	-	-
Scarico fumi Flue exit pipe Sorties de fumeés Rauchabzugsrohr	Superiore Ø150mm Upper Ø150mm Supérieure Ø150mm Oberer Ø150mm	Superiore Ø150mm Upper Ø150mm Supérieure Ø150mm Oberer Ø150mm	Superiore Ø130mm Upper Ø130mm Supérieure Ø130mm Oberer Ø130mm	Superiore Ø130mm Upper Ø130mm Supérieure Ø130mm Oberer Ø130mm	Superiore Ø130mm Upper Ø130mm Supérieure Ø130mm Oberer Ø130mm	Superiore Ø130mm Upper Ø130mm Supérieure Ø130mm Oberer Ø130mm
Autonomia - Burn time - Autonomie - Brenndauer	-	-	-	-	-	-
Pot. elettrica in esercizio Operating power Puissance électrique Betriebsleistung	-	-	-	-	-	-
Peso - Weight - Poids - Gewicht	80 Kg	80 Kg	205 kg	205 kg	195 kg	195 kg
Wi-Fi	-	-	-	-	-	-
Volume - Heating vol. - Vol. de chauffe - Heizvolumen	209 m <sup>3</sup>	209 m <sup>3</sup>	233 m <sup>3</sup>	233 m <sup>3</sup>	233 m <sup>3</sup>	233 m <sup>3</sup>
Energy class	A+	A+	A+	A+	A+	A+
D.M. 186	★★★★★	★★★★★	★★★★★	★★★★★	★★★★★	★★★★★
Flamme Verte	7 ★	7 ★	7 ★	7 ★	7 ★	7 ★
DTA	-	-	-	-	-	-









Tutti i dati tecnici e traduzioni raccolte in questo catalogo sono da ritenersi indicativi. Inoltre, i valori di resa, m<sup>3</sup>, kW, sono riferiti a prove di laboratorio e potrebbero variare se effettuate in altri locali. Nel continuo miglioramento dei suoi prodotti, Nobis si riserva di apportare in qualsiasi momento e senza preavviso modifiche tecniche ed estetiche. I colori sono da considerarsi puramente indicativi.

All of the technical informations and trasiations provided in this catalogue are purely indicative and cannot be deemed to the definitive. Moreover, the yields, m<sup>3</sup>, and kW provided always refer to laboratory tests and may vary if carried out at other locations. The company reserves the right to make changes at any time, without prior warning. The colours provided are to be considered purely indicative.

Toutes les informations techniques et les traductions de ce catalogue sont fournies à titre exclusivement indicatif. En outre, les rendements, m<sup>3</sup> et kW se réfèrent dans tous les cas aux essais de laboratoire et peuvent donc varier selon les différentes installations. La société se réserve le droit d'apporter des modifications à tout moment et sans préavis. Les couleurs sont uniquement indicatives.

Alle in diesem Katalog enthaltenen technischen Angaben und Bewertungen sind rein indikativ und können nicht als endgültig angesehen werden. Außerdem beziehen sich die angegebenen Erträge, m<sup>3</sup> und kW immer auf Labortests und können variieren, wenn sie an anderen Orten durchgeführt werden. Das Unternehmen behält sich das Recht vor, jederzeit und ohne Vorankündigung Änderungen vorzunehmen. Die angegebenen Farben sind lediglich als Richtwerte zu betrachten.

**nobis**  
YOUR STOVE, OUR PASSION



Tutti i dati tecnici e traduzioni raccolte in questo catalogo sono da ritenersi indicativi. Inoltre, i valori di rese, m<sup>3</sup>, kW, sono riferiti a prove di laboratorio e potrebbero variare se effettuate in altri locali. Nel continuo miglioramento dei suoi prodotti, Nobis si riserva di apportare in qualsiasi momento e senza preavviso modifiche tecniche ed estetiche. I colori sono da considerarsi puramente indicativi.

All technical information and translations provided in this catalogue are purely indicative and cannot be deemed definitive. Moreover, yields, m<sup>3</sup> and kW provided always refer to laboratory tests and may vary if carried out at other locations. The company reserves the right to make changes at any time without prior warning. The colours provided are purely indicative.

Toutes les informations techniques et les traductions de ce catalogue sont fournies à titre exclusivement indicatif. En outre, les rendements, m<sup>3</sup> et kW se réfèrent dans tous les cas aux essais de laboratoire et peuvent donc varier selon les différentes installations. La société se réserve le droit d'apporter des modifications à tout moment et sans préavis. Les couleurs sont uniquement indicatives.

Alle in diesem Katalog bereitgestellten technischen Informationen und Übersetzungen sind lediglich Richtwerte und können nicht als endgültig angesehen werden. Darüber hinaus Erträge, m<sup>3</sup> und kW beziehen sich immer auf Labortests und können variieren, wenn sie an anderen Standorten durchgeführt werden. Das Unternehmen behält sich das Recht vor, jederzeit und ohne vorherige Ankündigung Änderungen vorzunehmen. Die angegebenen Farben sind lediglich Richtwerte.

**nobis**  
YOUR STOVE, OUR PASSION

via Kupfer, 31  
25036 Palazzolo S/O  
Brescia (IT)

[www.nobisfire.it](http://www.nobisfire.it)

**nobis**  
YOUR STOVE, OUR PASSION